





1068447

**For KCC Use ONLY**

API # 15 - \_\_\_\_\_

**IN ALL CASES PLOT THE INTENDED WELL ON THE PLAT BELOW**

In all cases, please fully complete this side of the form. Include items 1 through 5 at the bottom of this page.

Operator: \_\_\_\_\_

Lease: \_\_\_\_\_

Well Number: \_\_\_\_\_

Field: \_\_\_\_\_

Number of Acres attributable to well: \_\_\_\_\_

QTR/QTR/QTR/QTR of acreage: \_\_\_\_\_ - \_\_\_\_\_ - \_\_\_\_\_ - \_\_\_\_\_

Location of Well: County: \_\_\_\_\_

\_\_\_\_\_ feet from  N /  S Line of Section

\_\_\_\_\_ feet from  E /  W Line of Section

Sec. \_\_\_\_\_ Twp. \_\_\_\_\_ S. R. \_\_\_\_\_  E  W

Is Section:  Regular or  Irregular

**If Section is Irregular, locate well from nearest corner boundary.**

Section corner used:  NE  NW  SE  SW

**PLAT**

Show location of the well. Show footage to the nearest lease or unit boundary line. Show the predicted locations of lease roads, tank batteries, pipelines and electrical lines, as required by the Kansas Surface Owner Notice Act (House Bill 2032). You may attach a separate plat if desired.

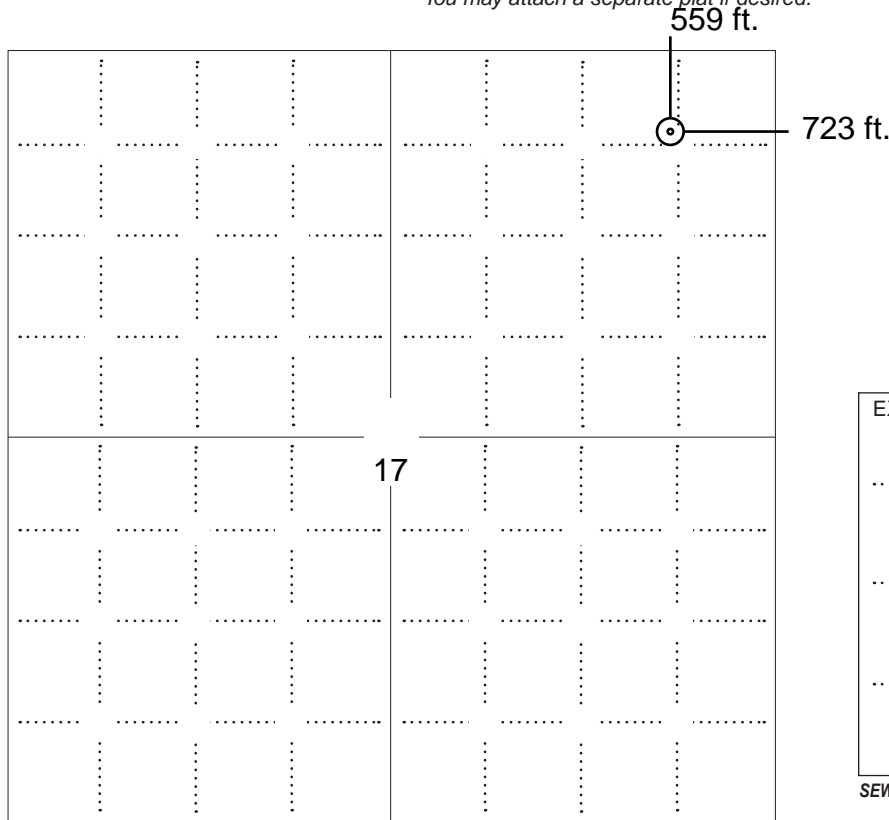

**LEGEND**

- Well Location
- Tank Battery Location
- Pipeline Location
- Electric Line Location
- Lease Road Location



**NOTE: In all cases locate the spot of the proposed drilling locaton.**

**In plotting the proposed location of the well, you must show:**

- The manner in which you are using the depicted plat by identifying section lines, i.e. 1 section, 1 section with 8 surrounding sections, 4 sections, etc.
- The distance of the proposed drilling location from the south / north and east / west outside section lines.
- The distance to the nearest lease or unit boundary line (in footage).
- If proposed location is located within a prorated or spaced field a certificate of acreage attribution plat must be attached: (C0-7 for oil wells; CG-8 for gas wells).
- The predicted locations of lease roads, tank batteries, pipelines, and electrical lines.



KANSAS CORPORATION COMMISSION 1068447  
OIL & GAS CONSERVATION DIVISION

Form CDP-1  
May 2010  
Form must be Typed

**APPLICATION FOR SURFACE PIT**

*Submit in Duplicate*

Operator Name: _____		License Number: _____	
Operator Address: _____			
Contact Person: _____		Phone Number: _____	
Lease Name & Well No.: _____		Pit Location (QQQQ): _____-_____-_____-_____	
Type of Pit: <input type="checkbox"/> Emergency Pit <input type="checkbox"/> Burn Pit <input type="checkbox"/> Settling Pit <input type="checkbox"/> Drilling Pit <input type="checkbox"/> Workover Pit <input type="checkbox"/> Haul-Off Pit <i>(If WP Supply API No. or Year Drilled)</i>		Pit is: <input type="checkbox"/> Proposed <input type="checkbox"/> Existing If Existing, date constructed: _____ Pit capacity: _____ (bbls)	
Is the pit located in a Sensitive Ground Water Area? <input type="checkbox"/> Yes <input type="checkbox"/> No		Chloride concentration: _____ mg/l <i>(For Emergency Pits and Settling Pits only)</i>	
Is the bottom below ground level? <input type="checkbox"/> Yes <input type="checkbox"/> No		Artificial Liner? <input type="checkbox"/> Yes <input type="checkbox"/> No	
How is the pit lined if a plastic liner is not used?			
Pit dimensions (all but working pits):    _____ Length (feet)    _____ Width (feet) <input type="checkbox"/> N/A: Steel Pits Depth from ground level to deepest point: _____ (feet) <input type="checkbox"/> No Pit			
If the pit is lined give a brief description of the liner material, thickness and installation procedure.		Describe procedures for periodic maintenance and determining liner integrity, including any special monitoring.	
Distance to nearest water well within one-mile of pit: _____ feet    Depth of water well _____ feet		Depth to shallowest fresh water _____ feet. Source of information: <input type="checkbox"/> measured <input type="checkbox"/> well owner <input type="checkbox"/> electric log <input type="checkbox"/> KDWR	
<b>Emergency, Settling and Burn Pits ONLY:</b> Producing Formation: _____ Number of producing wells on lease: _____ Barrels of fluid produced daily: _____ Does the slope from the tank battery allow all spilled fluids to flow into the pit? <input type="checkbox"/> Yes <input type="checkbox"/> No		<b>Drilling, Workover and Haul-Off Pits ONLY:</b> Type of material utilized in drilling/workover: _____ Number of working pits to be utilized: _____ Abandonment procedure: _____ Drill pits must be closed within 365 days of spud date.	
<p><b>Submitted Electronically</b></p>			

**KCC OFFICE USE ONLY**

Liner     Steel Pit     RFAC     RFAS

Date Received: \_\_\_\_\_ Permit Number: \_\_\_\_\_ Permit Date: \_\_\_\_\_ Lease Inspection:     Yes     No



# CERTIFICATION OF COMPLIANCE WITH THE KANSAS SURFACE OWNER NOTIFICATION ACT

*This form must be submitted with all Forms C-1 (Notice of Intent to Drill); CB-1 (Cathodic Protection Borehole Intent); T-1 (Request for Change of Operator Transfer of Injection or Surface Pit Permit); and CP-1 (Well Plugging Application). Any such form submitted without an accompanying Form KSONA-1 will be returned.*

Select the corresponding form being filed:  C-1 (Intent)  CB-1 (Cathodic Protection Borehole Intent)  T-1 (Transfer)  CP-1 (Plugging Application)

OPERATOR: License # \_\_\_\_\_  
Name: \_\_\_\_\_  
Address 1: \_\_\_\_\_  
Address 2: \_\_\_\_\_  
City: \_\_\_\_\_ State: \_\_\_\_\_ Zip: \_\_\_\_\_ + \_\_\_\_\_  
Contact Person: \_\_\_\_\_  
Phone: ( \_\_\_\_\_ ) \_\_\_\_\_ Fax: ( \_\_\_\_\_ ) \_\_\_\_\_  
Email Address: \_\_\_\_\_

Well Location:  
\_\_\_\_ - \_\_\_\_ - \_\_\_\_ - \_\_\_\_ Sec. \_\_\_\_ Twp. \_\_\_\_ S. R. \_\_\_\_  East  West  
County: \_\_\_\_\_  
Lease Name: \_\_\_\_\_ Well #: \_\_\_\_\_

*If filing a Form T-1 for multiple wells on a lease, enter the legal description of the lease below:*

**Surface Owner Information:**

Name: \_\_\_\_\_  
Address 1: \_\_\_\_\_  
Address 2: \_\_\_\_\_  
City: \_\_\_\_\_ State: \_\_\_\_\_ Zip: \_\_\_\_\_ + \_\_\_\_\_

*When filing a Form T-1 involving multiple surface owners, attach an additional sheet listing all of the information to the left for each surface owner. Surface owner information can be found in the records of the register of deeds for the county, and in the real estate property tax records of the county treasurer.*

*If this form is being submitted with a Form C-1 (Intent) or CB-1 (Cathodic Protection Borehole Intent), you must supply the surface owners and the KCC with a plat showing the predicted locations of lease roads, tank batteries, pipelines, and electrical lines. The locations shown on the plat are preliminary non-binding estimates. The locations may be entered on the Form C-1 plat, Form CB-1 plat, or a separate plat may be submitted.*

**Select one of the following:**

- I certify that, pursuant to the Kansas Surface Owner Notice Act (House Bill 2032), I have provided the following to the surface owner(s) of the land upon which the subject well is or will be located: 1) a copy of the Form C-1, Form CB-1, Form T-1, or Form CP-1 that I am filing in connection with this form; 2) if the form being filed is a Form C-1 or Form CB-1, the plat(s) required by this form; and 3) my operator name, address, phone number, fax, and email address.
- I have not provided this information to the surface owner(s). I acknowledge that, because I have not provided this information, the KCC will be required to send this information to the surface owner(s). To mitigate the additional cost of the KCC performing this task, I acknowledge that I am being charged a \$30.00 handling fee, payable to the KCC, which is enclosed with this form.

*If choosing the second option, submit payment of the \$30.00 handling fee with this form. If the fee is not received with this form, the KSONA-1 form and the associated Form C-1, Form CB-1, Form T-1, or Form CP-1 will be returned.*

I Submitted Electronically

**For KCC Use ONLY**

API # 15 - \_\_\_\_\_

**IN ALL CASES PLOT THE INTENDED WELL ON THE PLAT BELOW**

In all cases, please fully complete this side of the form. Include items 1 through 5 at the bottom of this page.

Operator: \_\_\_\_\_  
 Lease: \_\_\_\_\_  
 Well Number: \_\_\_\_\_  
 Field: \_\_\_\_\_  
 Number of Acres attributable to well: \_\_\_\_\_  
 QTR/QTR/QTR/QTR of acreage: \_\_\_\_\_ - \_\_\_\_\_ - \_\_\_\_\_ - \_\_\_\_\_

Location of Well: County: \_\_\_\_\_  
 \_\_\_\_\_ feet from  N /  S Line of Section  
 \_\_\_\_\_ feet from  E /  W Line of Section  
 Sec. \_\_\_\_\_ Twp. \_\_\_\_\_ S. R. \_\_\_\_\_  E  W

Is Section:  Regular or  Irregular

**If Section is Irregular, locate well from nearest corner boundary.**

Section corner used:  NE  NW  SE  SW

**PLAT**

Show location of the well. Show footage to the nearest lease or unit boundary line. Show the predicted locations of lease roads, tank batteries, pipelines and electrical lines, as required by the Kansas Surface Owner Notice Act (House Bill 2032).  
 You may attach a separate plat if desired.

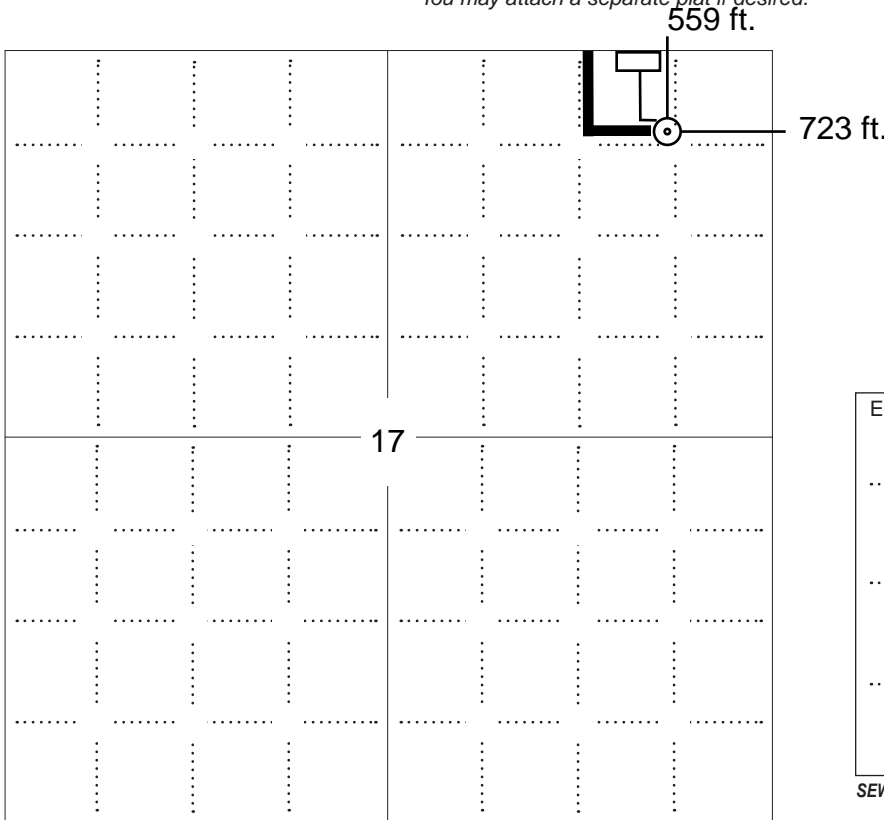

**LEGEND**

- Well Location
- Tank Battery Location
- Pipeline Location
- Electric Line Location
- Lease Road Location

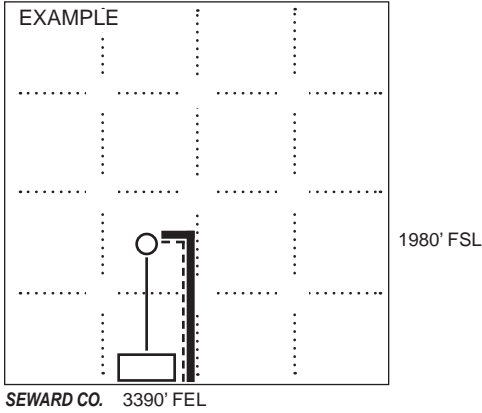

**NOTE: In all cases locate the spot of the proposed drilling locaton.**

**In plotting the proposed location of the well, you must show:**

1. The manner in which you are using the depicted plat by identifying section lines, i.e. 1 section, 1 section with 8 surrounding sections, 4 sections, etc.
2. The distance of the proposed drilling location from the south / north and east / west outside section lines.
3. The distance to the nearest lease or unit boundary line (in footage).
4. If proposed location is located within a prorated or spaced field a certificate of acreage attribution plat must be attached: (C0-7 for oil wells; CG-8 for gas wells).
5. The predicted locations of lease roads, tank batteries, pipelines, and electrical lines.



**Pro-Stake LLC**  
Oil Field & Construction Site Staking

P.O. Box 2324  
Garden City, Kansas 67846  
Office/Fax: (620) 276-6159  
Cell: (620) 272-1499

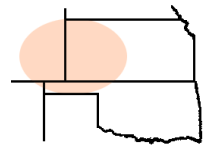

**g110211h**  
PLAT NO.

**9654**  
INVOICE NO.

**O'Brien Energy Resources Corp.**

OPERATOR

**Utz #1-17**

LEASE NAME

**Meade Co, Ks**

COUNTY

**17**

Sec.

**33s**

Twp.

**29w**

Rng.

**Main loc. = 660'FNL-660'FEL = 2664.9' gr.elev.**  
**Alt. #1 = 559'FNL-723'FEL = 2667.5' gr. elev.**

SCALE: N/A  
DATE STAKED: Oct. 27<sup>th</sup>, 2011  
MEASURED BY: Ben R.  
DRAWN BY: Luke R  
AUTHORIZED BY: Ed S. & Roger P.



LOCATION SPOT

**Directions:** From approx. 1 mile East of the East side of Plains Ks. at the intersection of Hwy 54 & Hwy 160 West – Now go 0.9 mile SW on Hwy 54 – Now go 6.4 mile South on 5 Rd - Now go 4 miles East on V Rd/Meade Lake Rd – Now go 1 mile North on 9 Rd to the NW corner of section 17-33s-29w – Now go 0.9 mile East on U Rd to ingress stake South into – Now go 660' South through pasture into main staked location.

**Final ingress must be verified with land owner or Operator.**

*This drawing does not constitute a monumented survey or a land survey plat.*  
*This drawing is for construction purposes only.*

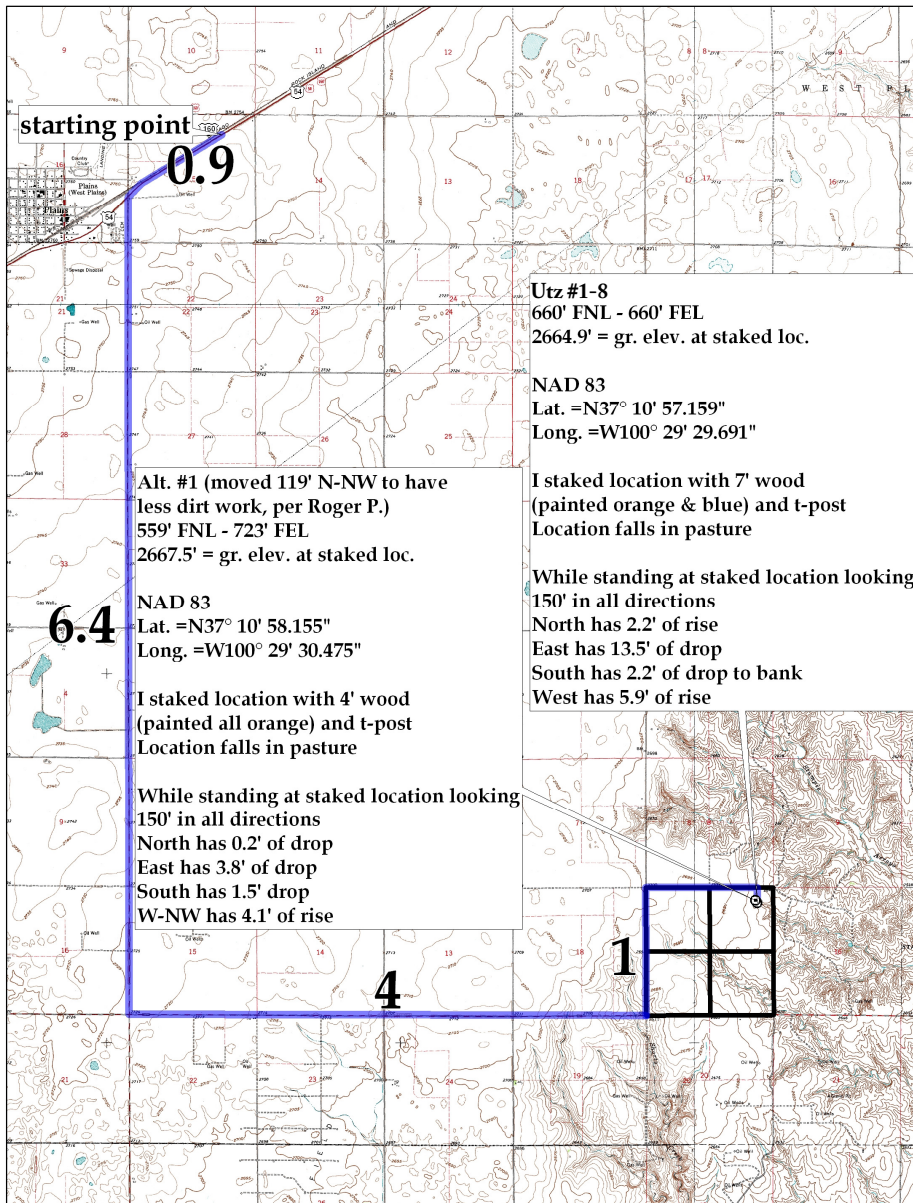

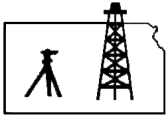

# Pro-Stake LLC

## Oil Field & Construction Site Staking

P.O. Box 2324  
Garden City, Kansas 67846  
Office/Fax: (620) 276-6159  
Cell: (620) 272-1499

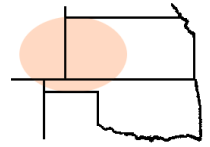

**g110211h**  
PLAT NO.

**9654**  
INVOICE NO.

**O'Brien Energy Resources Corp.**

OPERATOR

**Utz #1-17**

LEASE NAME

**Meade Co, Ks**

COUNTY

**17 33s 29w**  
Sec. Twp. Rng.

**Main loc. = 660'FNL-660'FEL = 2664.9' gr.elev.**  
**Alt. #1 = 559'FNL-723'FEL = 2667.5' gr. elev.**

LOCATION SPOT

SCALE: **1" = 1000'**  
DATE STAKED: **Oct. 27<sup>th</sup>, 2011**  
MEASURED BY: **Ben R.**  
DRAWN BY: **Luke R**  
AUTHORIZED BY: **Ed S. & Roger P.**



**Directions:** From approx. 1 mile East of the East side of Plains Ks. at the intersection of Hwy 54 & Hwy 160 West – Now go 0.9 mile SW on Hwy 54 – Now go 6.4 mile South on 5 Rd - Now go 4 miles East on V Rd/Meade Lake Rd – Now go 1 mile North on 9 Rd to the NW corner of section 17-33s-29w – Now go 0.9 mile East on U Rd to ingress stake South into – Now go 660' South through pasture into main staked location.

**Final ingress must be verified with land owner or Operator.**

***This drawing does not constitute a monumented survey or a land survey plat.***  
***This drawing is for construction purposes only.***

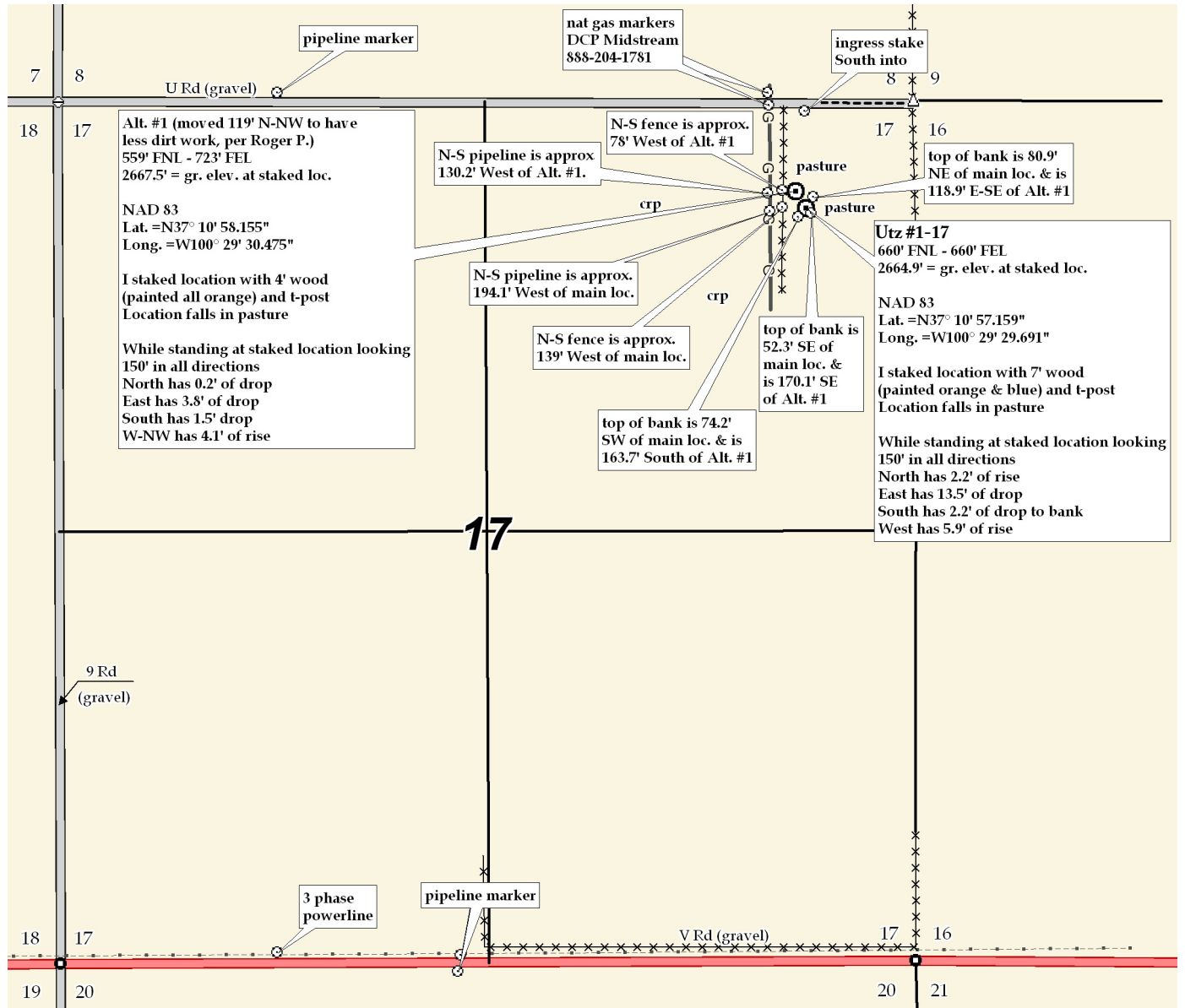

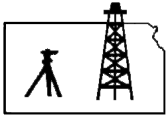

**Pro-Stake LLC**  
Oil Field & Construction Site Staking

P.O. Box 2324  
Garden City, Kansas 67846  
Office/Fax: (620) 276-6159  
Cell: (620) 272-1499

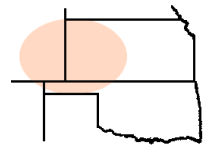

**g110211h**  
PLAT NO.

**9654**  
INVOICE NO.

**O'Brien Energy Resources Corp.**

OPERATOR

**Utz #1-17**

LEASE NAME

**Meade Co, Ks**

COUNTY

**17 33s 29w**  
Sec. Twp. Rng.

**Main loc. = 660'FNL-660'FEL = 2664.9' gr.elev.**  
**Alt. #1 = 559'FNL-723'FEL = 2667.5' gr. elev.**

LOCATION SPOT

SCALE: **1" = 1000'**  
DATE STAKED: **Oct. 27<sup>th</sup>, 2011**  
MEASURED BY: **Ben R.**  
DRAWN BY: **Luke R**  
AUTHORIZED BY: **Ed S. & Roger P.**



**Directions:** From approx. 1 mile East of the East side of Plains Ks. at the intersection of Hwy 54 & Hwy 160 West – Now go 0.9 mile SW on Hwy 54 – Now go 6.4 mile South on 5 Rd - Now go 4 miles East on V Rd/Meade Lake Rd – Now go 1 mile North on 9 Rd to the NW corner of section 17-33s-29w – Now go 0.9 mile East on U Rd to ingress stake South into – Now go 660' South through pasture into main staked location.

**Final ingress must be verified with land owner or Operator.**

***This drawing does not constitute a monumented survey or a land survey plat.***  
***This drawing is for construction purposes only.***

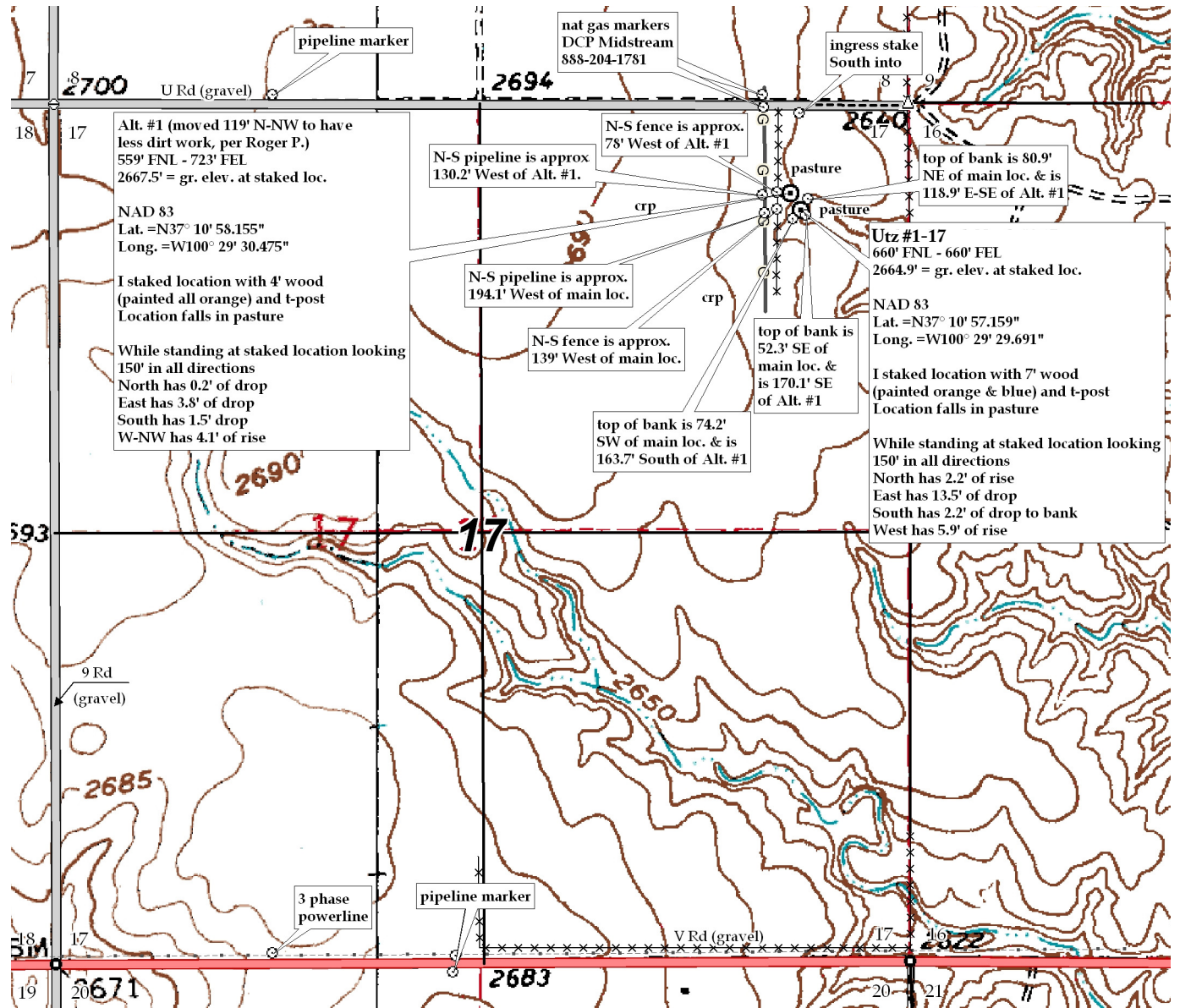



Conservation Division  
Finney State Office Building  
130 S. Market, Rm. 2078  
Wichita, KS 67202-3802



Phone: 316-337-6200  
Fax: 316-337-6211  
<http://kcc.ks.gov/>

Mark Sievers, Chairman  
Ward Loyd, Commissioner  
Thomas E. Wright, Commissioner

Sam Brownback, Governor

December 09, 2011

Joseph Forma  
O'Brien Energy Resources Corp.  
18 CONGRESS ST, STE 207  
PORTSMOUTH, NH 03801-4091

Re: Drilling Pit Application  
Utz 1-17  
NE/4 Sec.17-33S-29W  
Meade County, Kansas

Dear Joseph Forma:

District staff has inspected the above referenced location and has determined that the reserve pit shall be constructed **without slots**, the bottom shall be flat and reasonably level and the free fluids must be removed. The fluids are to be removed from the reserve pit as soon as the Hutchinson Salt section has been drilled through and displacement of the fluids into the reserve pit has occurred. The fluids should be removed again within 96 hours after drilling operations have ceased.

**If production casing is set all completion fluids shall be removed from the working pits daily. NO completion fluids or non-exempt wastes shall be placed in the reserve pit.**

The fluids should be taken to an authorized disposal well. Please call the District Office at (620) 225-8888 when the fluids have been removed. Please file form CDP-5 (August 2008), Exploration and Production Waste Transfer, through KOLAR within 30 days of fluid removal.

**A copy of this letter should be posted in the doghouse along with the approved Intent to Drill.** If you have any questions or concerns please feel free to contact the District Office at (620) 225-8888.