



1088180

For KCC Use ONLY

API # 15 - _____

IN ALL CASES PLOT THE INTENDED WELL ON THE PLAT BELOW

In all cases, please fully complete this side of the form. Include items 1 through 5 at the bottom of this page.

Operator: _____

Lease: _____

Well Number: _____

Field: _____

Number of Acres attributable to well: _____

QTR/QTR/QTR/QTR of acreage: _____ - _____ - _____ - _____

Location of Well: County: _____

_____ feet from N / S Line of Section

_____ feet from E / W Line of Section

Sec. _____ Twp. _____ S. R. _____ E W

Is Section: Regular or Irregular

If Section is Irregular, locate well from nearest corner boundary.

Section corner used: NE NW SE SW

PLAT

Show location of the well. Show footage to the nearest lease or unit boundary line. Show the predicted locations of lease roads, tank batteries, pipelines and electrical lines, as required by the Kansas Surface Owner Notice Act (House Bill 2032). You may attach a separate plat if desired.

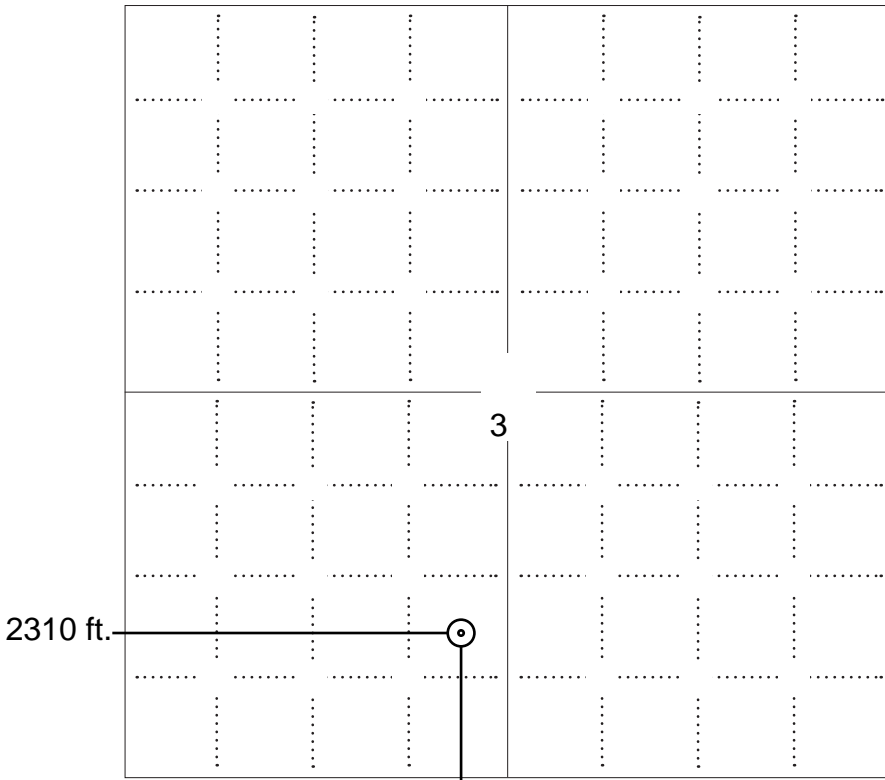

NOTE: In all cases locate the spot of the proposed drilling location.

LEGEND

- Well Location
- Tank Battery Location
- Pipeline Location
- Electric Line Location
- Lease Road Location



990 ft.

In plotting the proposed location of the well, you must show:

1. The manner in which you are using the depicted plat by identifying section lines, i.e. 1 section, 1 section with 8 surrounding sections, 4 sections, etc.
2. The distance of the proposed drilling location from the south / north and east / west outside section lines.
3. The distance to the nearest lease or unit boundary line (in footage).
4. If proposed location is located within a prorated or spaced field a certificate of acreage attribution plat must be attached: (C0-7 for oil wells; CG-8 for gas wells).
5. The predicted locations of lease roads, tank batteries, pipelines, and electrical lines.



KANSAS CORPORATION COMMISSION 1088180
OIL & GAS CONSERVATION DIVISION

Form CDP-1
May 2010
Form must be Typed

APPLICATION FOR SURFACE PIT

Submit in Duplicate

Operator Name: _____		License Number: _____	
Operator Address: _____			
Contact Person: _____		Phone Number: _____	
Lease Name & Well No.: _____		Pit Location (QQQQ): _____-_____-_____-_____	
Type of Pit: <input type="checkbox"/> Emergency Pit <input type="checkbox"/> Burn Pit <input type="checkbox"/> Settling Pit <input type="checkbox"/> Drilling Pit <input type="checkbox"/> Workover Pit <input type="checkbox"/> Haul-Off Pit <i>(If WP Supply API No. or Year Drilled)</i>		Pit is: <input type="checkbox"/> Proposed <input type="checkbox"/> Existing If Existing, date constructed: _____ Pit capacity: _____ (bbls)	
Is the pit located in a Sensitive Ground Water Area? <input type="checkbox"/> Yes <input type="checkbox"/> No		Chloride concentration: _____ mg/l <i>(For Emergency Pits and Settling Pits only)</i>	
Is the bottom below ground level? <input type="checkbox"/> Yes <input type="checkbox"/> No		Artificial Liner? <input type="checkbox"/> Yes <input type="checkbox"/> No	
How is the pit lined if a plastic liner is not used?			
Pit dimensions (all but working pits): _____ Length (feet) _____ Width (feet) <input type="checkbox"/> N/A: Steel Pits Depth from ground level to deepest point: _____ (feet) <input type="checkbox"/> No Pit			
If the pit is lined give a brief description of the liner material, thickness and installation procedure.		Describe procedures for periodic maintenance and determining liner integrity, including any special monitoring.	
Distance to nearest water well within one-mile of pit: _____ feet Depth of water well _____ feet		Depth to shallowest fresh water _____ feet. Source of information: <input type="checkbox"/> measured <input type="checkbox"/> well owner <input type="checkbox"/> electric log <input type="checkbox"/> KDWR	
Emergency, Settling and Burn Pits ONLY: Producing Formation: _____ Number of producing wells on lease: _____ Barrels of fluid produced daily: _____ Does the slope from the tank battery allow all spilled fluids to flow into the pit? <input type="checkbox"/> Yes <input type="checkbox"/> No		Drilling, Workover and Haul-Off Pits ONLY: Type of material utilized in drilling/workover: _____ Number of working pits to be utilized: _____ Abandonment procedure: _____ Drill pits must be closed within 365 days of spud date.	
<p>Submitted Electronically</p>			

KCC OFFICE USE ONLY

Liner Steel Pit RFAC RFAS

Date Received: _____ Permit Number: _____ Permit Date: _____ Lease Inspection: Yes No



CERTIFICATION OF COMPLIANCE WITH THE KANSAS SURFACE OWNER NOTIFICATION ACT

This form must be submitted with all Forms C-1 (Notice of Intent to Drill); CB-1 (Cathodic Protection Borehole Intent); T-1 (Request for Change of Operator Transfer of Injection or Surface Pit Permit); and CP-1 (Well Plugging Application). Any such form submitted without an accompanying Form KSONA-1 will be returned.

Select the corresponding form being filed: C-1 (Intent) CB-1 (Cathodic Protection Borehole Intent) T-1 (Transfer) CP-1 (Plugging Application)

OPERATOR: License # _____
Name: _____
Address 1: _____
Address 2: _____
City: _____ State: _____ Zip: _____ + _____
Contact Person: _____
Phone: (_____) _____ Fax: (_____) _____
Email Address: _____

Well Location:
____ - ____ - ____ - ____ Sec. ____ Twp. ____ S. R. ____ East West
County: _____
Lease Name: _____ Well #: _____

If filing a Form T-1 for multiple wells on a lease, enter the legal description of the lease below:

Surface Owner Information:

Name: _____
Address 1: _____
Address 2: _____
City: _____ State: _____ Zip: _____ + _____

When filing a Form T-1 involving multiple surface owners, attach an additional sheet listing all of the information to the left for each surface owner. Surface owner information can be found in the records of the register of deeds for the county, and in the real estate property tax records of the county treasurer.

If this form is being submitted with a Form C-1 (Intent) or CB-1 (Cathodic Protection Borehole Intent), you must supply the surface owners and the KCC with a plat showing the predicted locations of lease roads, tank batteries, pipelines, and electrical lines. The locations shown on the plat are preliminary non-binding estimates. The locations may be entered on the Form C-1 plat, Form CB-1 plat, or a separate plat may be submitted.

Select one of the following:

- I certify that, pursuant to the Kansas Surface Owner Notice Act (House Bill 2032), I have provided the following to the surface owner(s) of the land upon which the subject well is or will be located: 1) a copy of the Form C-1, Form CB-1, Form T-1, or Form CP-1 that I am filing in connection with this form; 2) if the form being filed is a Form C-1 or Form CB-1, the plat(s) required by this form; and 3) my operator name, address, phone number, fax, and email address.
- I have not provided this information to the surface owner(s). I acknowledge that, because I have not provided this information, the KCC will be required to send this information to the surface owner(s). To mitigate the additional cost of the KCC performing this task, I acknowledge that I am being charged a \$30.00 handling fee, payable to the KCC, which is enclosed with this form.

If choosing the second option, submit payment of the \$30.00 handling fee with this form. If the fee is not received with this form, the KSONA-1 form and the associated Form C-1, Form CB-1, Form T-1, or Form CP-1 will be returned.

I Submitted Electronically

I

KSONA - Potential Tank Battery Location and Lease Road

PLOT OF THE INTENDED WELL

Operator: McCoy Petroleum Corporation
 Lease: KARLIN "B" #1-3
 Well Number: #1-3
 Field: Wildcat
 Number of Acres attributable to well: 160
 QTR/QTR/QTR/QTR of acreage: _____ SW

Location of Well: County: NE SE SW Logan Co., KS

990 feet from N / S Line of Section
2310 feet from E / W Line of Section

Sec 3 Twp. 11 S Rng. 33 E W

Is Section Regular or Irregular

If Section is Irregular, locate well from nearest corner boundary.



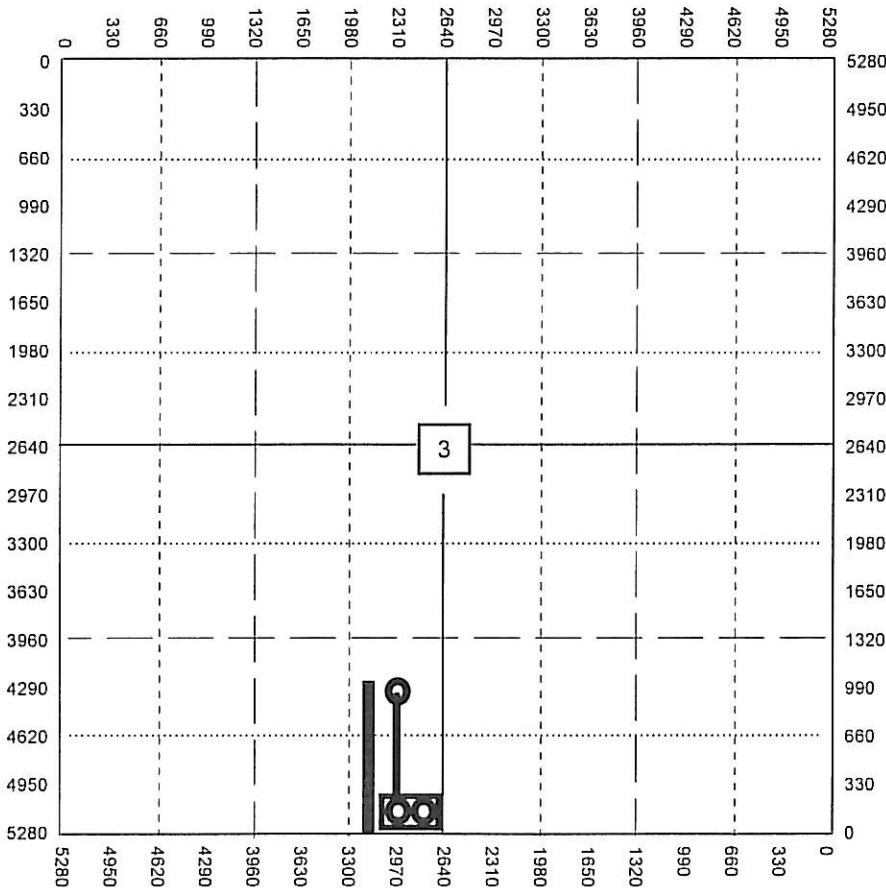

Section corner used: NE NW SE SW

PLAT

*Show the predicted locations of lease roads, tank batteries, pipelines and electrical lines,
 as required by the Kansas Surface Owner Notice Act (House Bill 2032).*



LEGEND

-  Well Location
-  Tank Battery Location
-  Pipeline Location
-  Electric Line Location
-  Lease Road Location

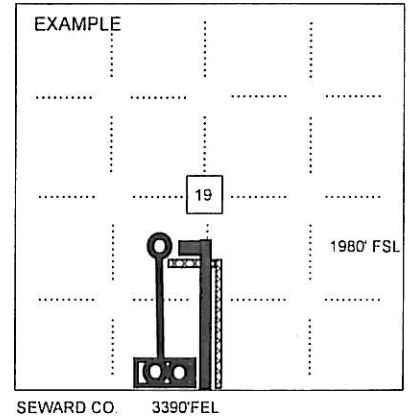

NOTE: Spot of the proposed drilling location.