

For KCC Use:

Effective Date: \_\_\_\_\_

District # \_\_\_\_\_

SGA?  Yes  No

KANSAS CORPORATION COMMISSION  
OIL & GAS CONSERVATION DIVISION

Form C-1

March 2010

Form must be Typed  
Form must be Signed  
All blanks must be Filled

NOTICE OF INTENT TO DRILL

Must be approved by KCC five (5) days prior to commencing well

Form KSONA-1, Certification of Compliance with the Kansas Surface Owner Notification Act, MUST be submitted with this form.

Expected Spud Date: \_\_\_\_\_  
month day year

OPERATOR: License# \_\_\_\_\_

Name: \_\_\_\_\_

Address 1: \_\_\_\_\_

Address 2: \_\_\_\_\_

City: \_\_\_\_\_ State: \_\_\_\_\_ Zip: \_\_\_\_\_ + \_\_\_\_\_

Contact Person: \_\_\_\_\_

Phone: \_\_\_\_\_

CONTRACTOR: License# \_\_\_\_\_

Name: \_\_\_\_\_

Well Drilled For:

Well Class:

Type Equipment:

- |   |                                   |                                    |                                     |
|---|-----------------------------------|------------------------------------|-------------------------------------|
| <input type="checkbox"/> Oil                        | <input type="checkbox"/> Enh Rec  | <input type="checkbox"/> Infield   | <input type="checkbox"/> Mud Rotary |
| <input type="checkbox"/> Gas                        | <input type="checkbox"/> Storage  | <input type="checkbox"/> Pool Ext. | <input type="checkbox"/> Air Rotary |
|   | <input type="checkbox"/> Disposal | <input type="checkbox"/> Wildcat   | <input type="checkbox"/> Cable      |
| <input type="checkbox"/> Seismic ; _____ # of Holes | <input type="checkbox"/> Other    |                                    |                                     |
| <input type="checkbox"/> Other: _____               |                                   |                                    |                                     |

If OWWO: old well information as follows:

Operator: \_\_\_\_\_

Well Name: \_\_\_\_\_

Original Completion Date: \_\_\_\_\_ Original Total Depth: \_\_\_\_\_

Directional, Deviated or Horizontal wellbore?  Yes  No

If Yes, true vertical depth: \_\_\_\_\_

Bottom Hole Location: \_\_\_\_\_

KCC DKT #: \_\_\_\_\_

Spot Description: \_\_\_\_\_

\_\_\_\_\_ - \_\_\_\_\_ - \_\_\_\_\_ Sec. \_\_\_\_\_ Twp. \_\_\_\_\_ S. R. \_\_\_\_\_  E  W  
(Q/Q/Q/Q) \_\_\_\_\_ feet from  N /  S Line of Section

\_\_\_\_\_ feet from  E /  W Line of Section

Is SECTION:  Regular  Irregular?

(Note: Locate well on the Section Plat on reverse side)

County: \_\_\_\_\_

Lease Name: \_\_\_\_\_ Well #: \_\_\_\_\_

Field Name: \_\_\_\_\_

Is this a Prorated / Spaced Field?  Yes  No

Target Formation(s): \_\_\_\_\_

Nearest Lease or unit boundary line (in footage): \_\_\_\_\_

Ground Surface Elevation: \_\_\_\_\_ feet MSL

Water well within one-quarter mile:  Yes  No

Public water supply well within one mile:  Yes  No

Depth to bottom of fresh water: \_\_\_\_\_

Depth to bottom of usable water: \_\_\_\_\_

Surface Pipe by Alternate:  I  II

Length of Surface Pipe Planned to be set: \_\_\_\_\_

Length of Conductor Pipe (if any): \_\_\_\_\_

Projected Total Depth: \_\_\_\_\_

Formation at Total Depth: \_\_\_\_\_

Water Source for Drilling Operations:

Well  Farm Pond  Other: \_\_\_\_\_

DWR Permit #: \_\_\_\_\_

(Note: Apply for Permit with DWR  )

Will Cores be taken?  Yes  No

If Yes, proposed zone: \_\_\_\_\_

AFFIDAVIT

The undersigned hereby affirms that the drilling, completion and eventual plugging of this well will comply with K.S.A. 55 et. seq.

It is agreed that the following minimum requirements will be met:

1. Notify the appropriate district office **prior** to spudding of well;
2. A copy of the approved notice of intent to drill **shall be** posted on each drilling rig;
3. The minimum amount of surface pipe as specified below **shall be set** by circulating cement to the top; in all cases surface pipe **shall be set** through all unconsolidated materials plus a minimum of 20 feet into the underlying formation.
4. If the well is dry hole, an agreement between the operator and the district office on plug length and placement is necessary **prior to plugging**;
5. The appropriate district office will be notified before well is either plugged or production casing is cemented in;
6. If an ALTERNATE II COMPLETION, production pipe shall be cemented from below any usable water to surface within **120 DAYS** of spud date. Or pursuant to Appendix "B" - Eastern Kansas surface casing order #133,891-C, which applies to the KCC District 3 area, alternate II cementing must be completed within 30 days of the spud date or the well shall be plugged. **In all cases, NOTIFY district office** prior to any cementing.

Submitted Electronically

**For KCC Use ONLY**

API # 15 - \_\_\_\_\_

Conductor pipe required \_\_\_\_\_ feet

Minimum surface pipe required \_\_\_\_\_ feet per ALT.  I  II

Approved by: \_\_\_\_\_

**This authorization expires:** \_\_\_\_\_  
(This authorization void if drilling not started within 12 months of approval date.)

Spud date: \_\_\_\_\_ Agent: \_\_\_\_\_

Remember to:

- File Certification of Compliance with the Kansas Surface Owner Notification Act (KSONA-1) with Intent to Drill;
- File Drill Pit Application (form CDP-1) with Intent to Drill;
- File Completion Form ACO-1 within 120 days of spud date;
- File acreage attribution plat according to field proration orders;
- Notify appropriate district office 48 hours prior to workover or re-entry;
- Submit plugging report (CP-4) after plugging is completed (within 60 days);
- Obtain written approval before disposing or injecting salt water.
- If well will not be drilled or permit has expired (See: authorized expiration date) please check the box below and return to the address below.

Well will not be drilled or Permit Expired Date: \_\_\_\_\_  
Signature of Operator or Agent:

E  
 W

**For KCC Use ONLY**

API # 15 - \_\_\_\_\_

**IN ALL CASES PLOT THE INTENDED WELL ON THE PLAT BELOW**

In all cases, please fully complete this side of the form. Include items 1 through 5 at the bottom of this page.

Operator: \_\_\_\_\_  
 Lease: \_\_\_\_\_  
 Well Number: \_\_\_\_\_  
 Field: \_\_\_\_\_  
 Number of Acres attributable to well: \_\_\_\_\_  
 QTR/QTR/QTR/QTR of acreage: \_\_\_\_\_ - \_\_\_\_\_ - \_\_\_\_\_ - \_\_\_\_\_

Location of Well: County: \_\_\_\_\_  
 \_\_\_\_\_ feet from  N /  S Line of Section  
 \_\_\_\_\_ feet from  E /  W Line of Section  
 Sec. \_\_\_\_\_ Twp. \_\_\_\_\_ S. R. \_\_\_\_\_  E  W

Is Section:  Regular or  Irregular

**If Section is Irregular, locate well from nearest corner boundary.**

Section corner used:  NE  NW  SE  SW

**PLAT**

Show location of the well. Show footage to the nearest lease or unit boundary line. Show the predicted locations of lease roads, tank batteries, pipelines and electrical lines, as required by the Kansas Surface Owner Notice Act (House Bill 2032). You may attach a separate plat if desired.

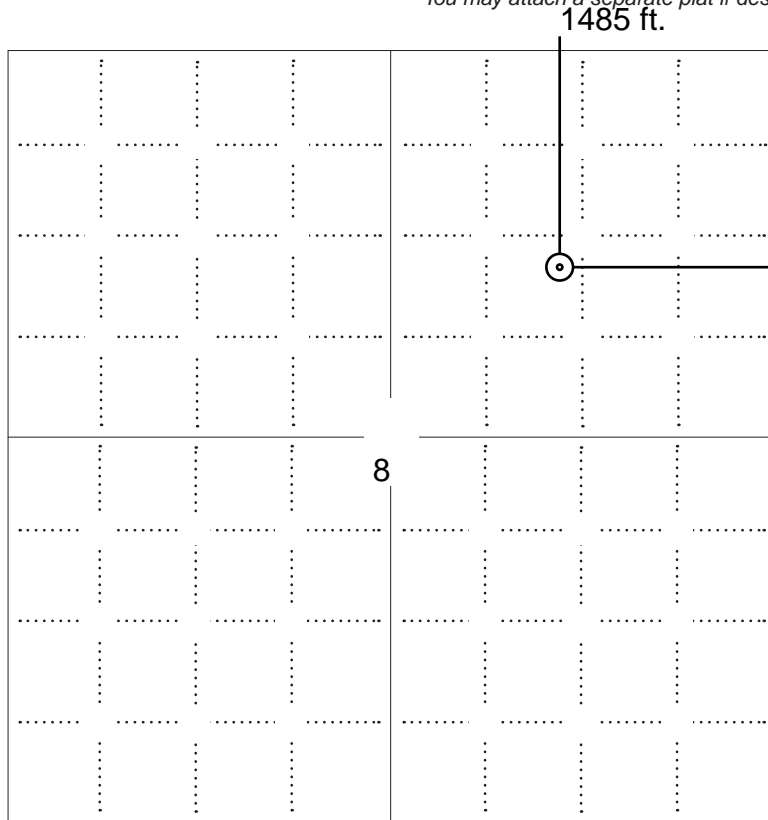

**LEGEND**

- Well Location
- Tank Battery Location
- Pipeline Location
- Electric Line Location
- Lease Road Location



**NOTE: In all cases locate the spot of the proposed drilling locaton.**

**In plotting the proposed location of the well, you must show:**

1. The manner in which you are using the depicted plat by identifying section lines, i.e. 1 section, 1 section with 8 surrounding sections, 4 sections, etc.
2. The distance of the proposed drilling location from the south / north and east / west outside section lines.
3. The distance to the nearest lease or unit boundary line (in footage).
4. If proposed location is located within a prorated or spaced field a certificate of acreage attribution plat must be attached: (C0-7 for oil wells; CG-8 for gas wells).
5. The predicted locations of lease roads, tank batteries, pipelines, and electrical lines.

KANSAS CORPORATION COMMISSION  
OIL & GAS CONSERVATION DIVISION

Form CDP-1  
May 2010  
Form must be Typed

**APPLICATION FOR SURFACE PIT**

*Submit in Duplicate*

Operator Name: _____		License Number: _____	
Operator Address: _____			
Contact Person: _____		Phone Number: _____	
Lease Name & Well No.: _____		Pit Location (QQQQ): _____-_____-_____-_____	
Type of Pit: <input type="checkbox"/> Emergency Pit <input type="checkbox"/> Burn Pit <input type="checkbox"/> Settling Pit <input type="checkbox"/> Drilling Pit <input type="checkbox"/> Workover Pit <input type="checkbox"/> Haul-Off Pit <i>(If WP Supply API No. or Year Drilled)</i>		Pit is: <input type="checkbox"/> Proposed <input type="checkbox"/> Existing If Existing, date constructed: _____ Pit capacity: _____ (bbls)	
Is the pit located in a Sensitive Ground Water Area? <input type="checkbox"/> Yes <input type="checkbox"/> No		Chloride concentration: _____ mg/l <i>(For Emergency Pits and Settling Pits only)</i>	
Is the bottom below ground level? <input type="checkbox"/> Yes <input type="checkbox"/> No		Artificial Liner? <input type="checkbox"/> Yes <input type="checkbox"/> No	
How is the pit lined if a plastic liner is not used? _____			
Pit dimensions (all but working pits):    _____ Length (feet)    _____ Width (feet) <input type="checkbox"/> N/A: Steel Pits Depth from ground level to deepest point: _____ (feet) <input type="checkbox"/> No Pit			
If the pit is lined give a brief description of the liner material, thickness and installation procedure.		Describe procedures for periodic maintenance and determining liner integrity, including any special monitoring.	
Distance to nearest water well within one-mile of pit: _____ feet    Depth of water well _____ feet		Depth to shallowest fresh water _____ feet. Source of information: <input type="checkbox"/> measured <input type="checkbox"/> well owner <input type="checkbox"/> electric log <input type="checkbox"/> KDWR	
<b>Emergency, Settling and Burn Pits ONLY:</b> Producing Formation: _____ Number of producing wells on lease: _____ Barrels of fluid produced daily: _____ Does the slope from the tank battery allow all spilled fluids to flow into the pit? <input type="checkbox"/> Yes <input type="checkbox"/> No		<b>Drilling, Workover and Haul-Off Pits ONLY:</b> Type of material utilized in drilling/workover: _____ Number of working pits to be utilized: _____ Abandonment procedure: _____ _____ Drill pits must be closed within 365 days of spud date.	
Submitted Electronically			

<b>KCC OFFICE USE ONLY</b>			
<input type="checkbox"/> Liner <input type="checkbox"/> Steel Pit <input type="checkbox"/> RFAC <input type="checkbox"/> RFAS			
Date Received: _____ Permit Number: _____ Permit Date: _____ Lease Inspection: <input type="checkbox"/> Yes <input type="checkbox"/> No			

KANSAS CORPORATION COMMISSION  
OIL & GAS CONSERVATION DIVISION

Form KSONA-1  
January 2014  
**Form Must Be Typed**  
**Form must be Signed**  
**All blanks must be Filled**

**CERTIFICATION OF COMPLIANCE WITH THE  
KANSAS SURFACE OWNER NOTIFICATION ACT**

*This form must be submitted with all Forms C-1 (Notice of Intent to Drill); CB-1 (Cathodic Protection Borehole Intent); T-1 (Request for Change of Operator Transfer of Injection or Surface Pit Permit); and CP-1 (Well Plugging Application). Any such form submitted without an accompanying Form KSONA-1 will be returned.*

Select the corresponding form being filed:  C-1 (Intent)  CB-1 (Cathodic Protection Borehole Intent)  T-1 (Transfer)  CP-1 (Plugging Application)

OPERATOR: License # \_\_\_\_\_  
Name: \_\_\_\_\_  
Address 1: \_\_\_\_\_  
Address 2: \_\_\_\_\_  
City: \_\_\_\_\_ State: \_\_\_\_\_ Zip: \_\_\_\_\_ + \_\_\_\_\_  
Contact Person: \_\_\_\_\_  
Phone: ( \_\_\_\_\_ ) \_\_\_\_\_ Fax: ( \_\_\_\_\_ ) \_\_\_\_\_  
Email Address: \_\_\_\_\_

Well Location:  
\_\_\_\_ - \_\_\_\_ - \_\_\_\_ - \_\_\_\_ Sec. \_\_\_\_ Twp. \_\_\_\_ S. R. \_\_\_\_  East  West  
County: \_\_\_\_\_  
Lease Name: \_\_\_\_\_ Well #: \_\_\_\_\_

*If filing a Form T-1 for multiple wells on a lease, enter the legal description of the lease below:*

**Surface Owner Information:**

Name: \_\_\_\_\_  
Address 1: \_\_\_\_\_  
Address 2: \_\_\_\_\_  
City: \_\_\_\_\_ State: \_\_\_\_\_ Zip: \_\_\_\_\_ + \_\_\_\_\_

*When filing a Form T-1 involving multiple surface owners, attach an additional sheet listing all of the information to the left for each surface owner. Surface owner information can be found in the records of the register of deeds for the county, and in the real estate property tax records of the county treasurer.*

*If this form is being submitted with a Form C-1 (Intent) or CB-1 (Cathodic Protection Borehole Intent), you must supply the surface owners and the KCC with a plat showing the predicted locations of lease roads, tank batteries, pipelines, and electrical lines. The locations shown on the plat are preliminary non-binding estimates. The locations may be entered on the Form C-1 plat, Form CB-1 plat, or a separate plat may be submitted.*

**Select one of the following:**

- I certify that, pursuant to the Kansas Surface Owner Notice Act (House Bill 2032), I have provided the following to the surface owner(s) of the land upon which the subject well is or will be located: 1) a copy of the Form C-1, Form CB-1, Form T-1, or Form CP-1 that I am filing in connection with this form; 2) if the form being filed is a Form C-1 or Form CB-1, the plat(s) required by this form; and 3) my operator name, address, phone number, fax, and email address.
- I have not provided this information to the surface owner(s). I acknowledge that, because I have not provided this information, the KCC will be required to send this information to the surface owner(s). To mitigate the additional cost of the KCC performing this task, I acknowledge that I must provide the name and address of the surface owner by filling out the top section of this form and that I am being charged a \$30.00 handling fee, payable to the KCC, which is enclosed with this form.

*If choosing the second option, submit payment of the \$30.00 handling fee with this form. If the fee is not received with this form, the KSONA-1 form and the associated Form C-1, Form CB-1, Form T-1, or Form CP-1 will be returned.*

I Submitted Electronically

I

MCCOY PETROLEUM CORPORATION  
 LONG RANCH LEASE  
 NE. 1/4, SECTION 8, T32S, R19W  
 COMANCHE COUNTY, KANSAS

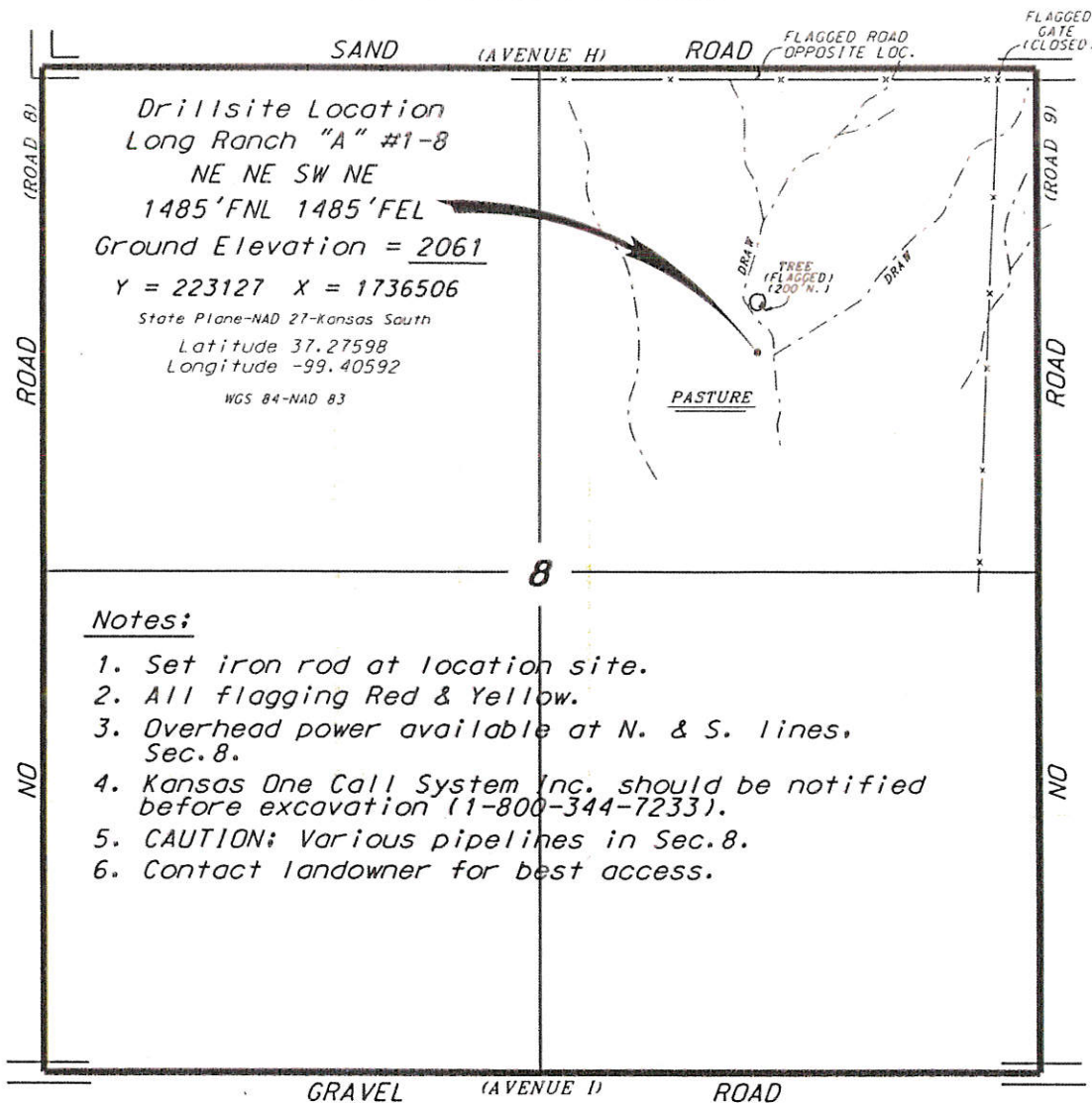

\*Ingress and egress to location as shown on this plat is for usage only and may not be legally opened for public use. Contact landowner, tenant and county road department for access.

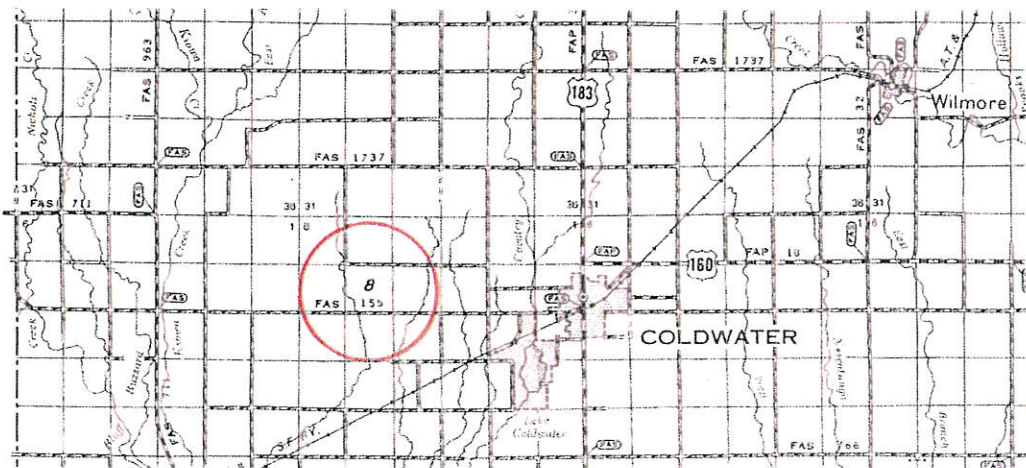

• Controlling data is based upon the best maps and photographs available to us and upon a regular station of land containing 640 acres.  
 • Approximate section lines were determined using the normal standard of care of oilfield surveyors practicing in the state of Kansas. The section corners, which establish the precise section lines, were not necessarily located, and the exact location of the drillsite location in the section is not guaranteed. Therefore, the operator securing this service and accepting this plat and all other parties relying thereon agree to hold Central Kansas Oilfield Services, Inc., its officers and employees harmless from all losses, costs and expenses and said entities released from any liability from incidental or consequential damages.  
 • Elevations derived from National Geodetic Vertical Datum.

Date February 12, 2019



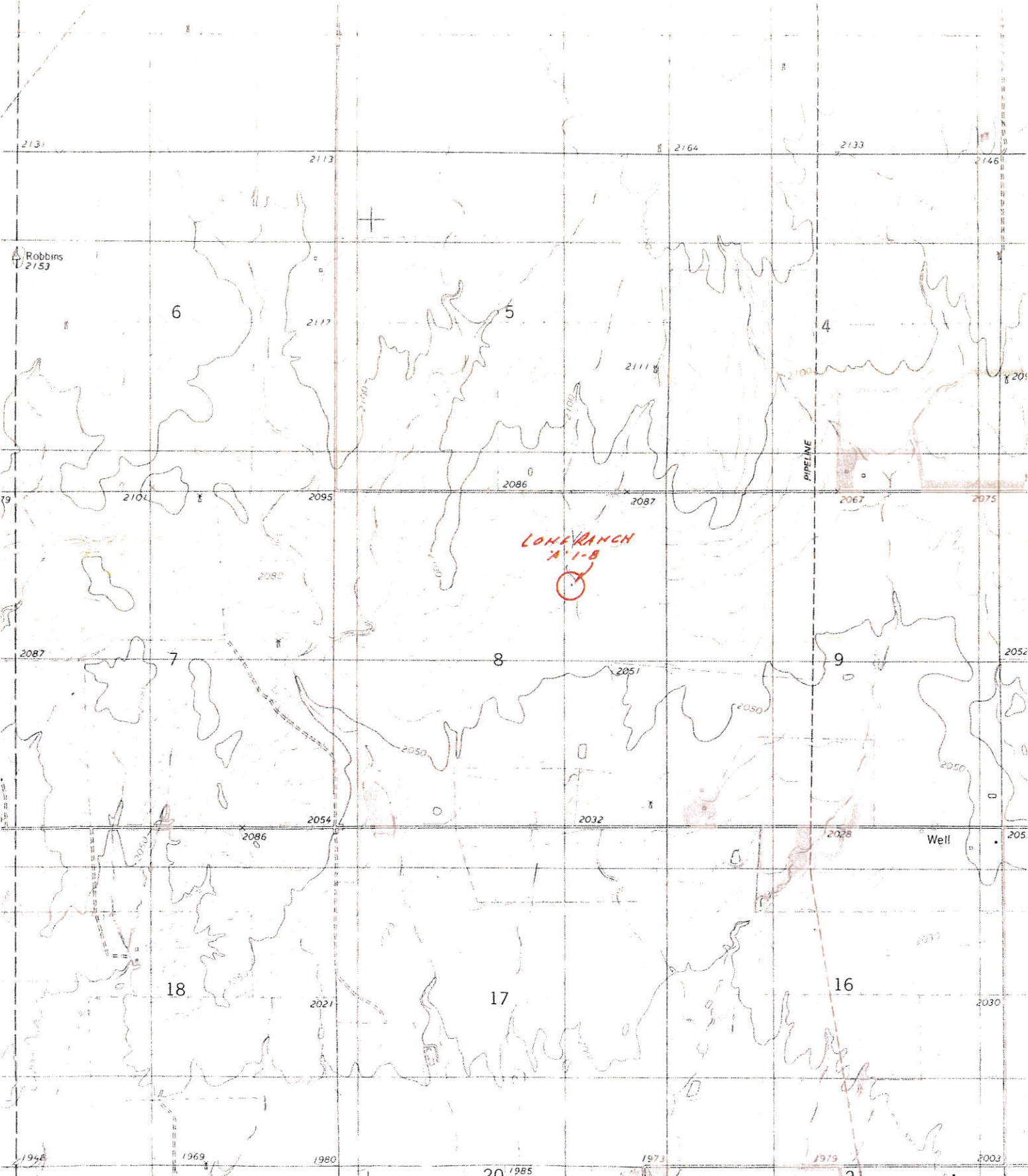

24 000  
 1940 1969 1980 1985 1973 1979 2003  
 20 21  
 R 19 W '62 25' '64  
 INFERIOR—GEOLOGICAL SURVEY RESTON VIRGINIA  
 660000E

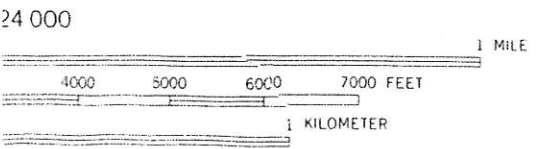

VAL 10 FEET  
 TICAL DATUM OF 1929

- ROAD CLASSIFICATION**
- Primary highway, hard surface
  - Secondary highway, hard surface
  - Light duty road, improved surface
  - Unimproved road
  - Interstate Route
  - U S Route

# KSONA - Potential Tank Battery Location and Lease Road

## PLOT OF THE INTENDED WELL

Operator: McCoy Petroleum Corporation  
 Lease: LONG RANCH "A" #1-8  
 Well Number: #1-8  
 Field: Wildcat  
 Number of Acres attributable to well: 160  
 QTR/QTR/QTR/QTR of acreage: NE

Location of Well: County: NE NE SW NE Comanche Co.  
1485 feet from  N /  S Line of Section  
1485 feet from  E /  W Line of Section  
 Sec 8 Twp. 32 S Rng. 19  E  W  
 Is Section  Regular or  Irregular

**If Section is Irregular, locate well from nearest corner boundary.**  
 Section corner used:  NE  NW  SE  SW

### PLAT

*Show the predicted locations of lease roads, tank batteries, pipelines and electrical lines,  
 as required by the Kansas Surface Owner Notice Act (House Bill 2032).*

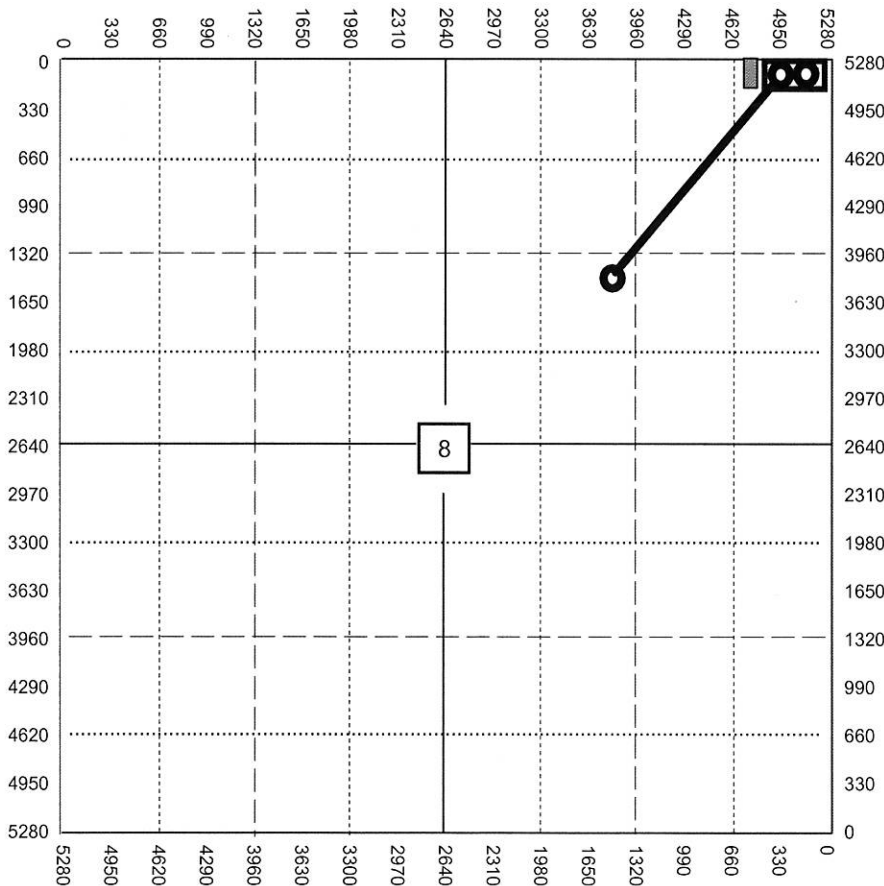

- LEGEND**
- Well Location
  - Tank Battery Location
  - Pipeline Location
  - Electric Line Location
  - Lease Road Location

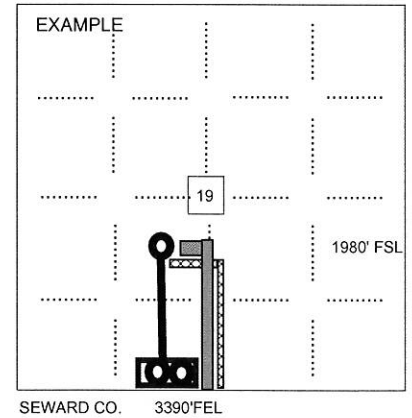

**NOTE: Spot of the proposed drilling location.**



Conservation Division  
266 N. Main St., Ste. 220  
Wichita, KS 67202-1513

Phone: 316-337-6200  
Fax: 346-337-6211  
<http://kcc.ks.gov/>

Dwight D. Keen, Chair  
Shari Feist Albrecht, Commissioner  
Jay Scott Emler, Commissioner

Laura Kelly, Governor

February 14, 2019

Scott Hampel  
McCoy Petroleum Corporation  
9342 E CENTRAL  
WICHITA, KS 67206-2573

Re: Drilling Pit Application  
LONG RANCH "A" 1-8  
NE/4 Sec.08-32S-19W  
Comanche County, Kansas

Dear Scott Hampel:

District staff has inspected the above referenced location and has determined that an unsealed condition will present a pollution threat to water resources.

District staff has recommended that the reserve pit be lined with bentonite or native clay, constructed **without slots**, the bottom shall be flat and reasonably level and the free fluids must be removed. The fluids are to be removed from the reserve pit as soon as the Hutchinson Salt section has been drilled through and displacement of the fluids into the reserve pit has occurred. The fluids should be removed again within 72 hours after drilling operations have ceased.

**If production casing is set all completion fluids shall be removed from the working pits daily. NO completion fluids or non-exempt wastes shall be placed in the reserve pit.**

The fluids should be taken to an authorized disposal well. Please call the District Office at (620) 682-7933 when the fluids have been removed. Please file form CDP-5 (August 2008), Exploration and Production Waste Transfer, through KOLAR within 30 days of fluid removal.

**A copy of this letter should be posted in the doghouse along with the approved Intent to Drill.** If you have any questions or concerns please feel free to contact the District Office at (620) 682-7933.