

For KCC Use:

Effective Date: _____

District # _____

SGA? Yes No

KANSAS CORPORATION COMMISSION
OIL & GAS CONSERVATION DIVISION

Form C-1

March 2010

Form must be Typed
Form must be Signed
All blanks must be Filled

NOTICE OF INTENT TO DRILL

Must be approved by KCC five (5) days prior to commencing well

Form KSONA-1, Certification of Compliance with the Kansas Surface Owner Notification Act, MUST be submitted with this form.

Expected Spud Date: _____
month day year

OPERATOR: License# _____

Name: _____

Address 1: _____

Address 2: _____

City: _____ State: _____ Zip: _____ + _____

Contact Person: _____

Phone: _____

CONTRACTOR: License# _____

Name: _____

Well Drilled For:

Well Class:

Type Equipment:

- | | | | |
|---|-----------------------------------|------------------------------------|-------------------------------------|
| <input type="checkbox"/> Oil | <input type="checkbox"/> Enh Rec | <input type="checkbox"/> Infield | <input type="checkbox"/> Mud Rotary |
| <input type="checkbox"/> Gas | <input type="checkbox"/> Storage | <input type="checkbox"/> Pool Ext. | <input type="checkbox"/> Air Rotary |
| | <input type="checkbox"/> Disposal | <input type="checkbox"/> Wildcat | <input type="checkbox"/> Cable |
| <input type="checkbox"/> Seismic ; _____ # of Holes | <input type="checkbox"/> Other | | |
| <input type="checkbox"/> Other: _____ | | | |

If OWWO: old well information as follows:

Operator: _____

Well Name: _____

Original Completion Date: _____ Original Total Depth: _____

Directional, Deviated or Horizontal wellbore? Yes No

If Yes, true vertical depth: _____

Bottom Hole Location: _____

KCC DKT #: _____

Spot Description: _____

_____ - _____ - _____ Sec. _____ Twp. _____ S. R. _____ E W
(Q/Q/Q/Q) _____ feet from N / S Line of Section

_____ feet from E / W Line of Section

Is SECTION: Regular Irregular?

(Note: Locate well on the Section Plat on reverse side)

County: _____

Lease Name: _____ Well #: _____

Field Name: _____

Is this a Prorated / Spaced Field? Yes No

Target Formation(s): _____

Nearest Lease or unit boundary line (in footage): _____

Ground Surface Elevation: _____ feet MSL

Water well within one-quarter mile: Yes No

Public water supply well within one mile: Yes No

Depth to bottom of fresh water: _____

Depth to bottom of usable water: _____

Surface Pipe by Alternate: I II

Length of Surface Pipe Planned to be set: _____

Length of Conductor Pipe (if any): _____

Projected Total Depth: _____

Formation at Total Depth: _____

Water Source for Drilling Operations:

Well Farm Pond Other: _____

DWR Permit #: _____

(Note: Apply for Permit with DWR)

Will Cores be taken? Yes No

If Yes, proposed zone: _____

AFFIDAVIT

The undersigned hereby affirms that the drilling, completion and eventual plugging of this well will comply with K.S.A. 55 et. seq.

It is agreed that the following minimum requirements will be met:

1. Notify the appropriate district office **prior** to spudding of well;
2. A copy of the approved notice of intent to drill **shall be** posted on each drilling rig;
3. The minimum amount of surface pipe as specified below **shall be set** by circulating cement to the top; in all cases surface pipe **shall be set** through all unconsolidated materials plus a minimum of 20 feet into the underlying formation.
4. If the well is dry hole, an agreement between the operator and the district office on plug length and placement is necessary **prior to plugging**;
5. The appropriate district office will be notified before well is either plugged or production casing is cemented in;
6. If an ALTERNATE II COMPLETION, production pipe shall be cemented from below any usable water to surface within **120 DAYS** of spud date. Or pursuant to Appendix "B" - Eastern Kansas surface casing order #133,891-C, which applies to the KCC District 3 area, alternate II cementing must be completed within 30 days of the spud date or the well shall be plugged. **In all cases, NOTIFY district office** prior to any cementing.

Submitted Electronically

For KCC Use ONLY

API # 15 - _____

Conductor pipe required _____ feet

Minimum surface pipe required _____ feet per ALT. I II

Approved by: _____

This authorization expires: _____
(This authorization void if drilling not started within 12 months of approval date.)

Spud date: _____ Agent: _____

Remember to:

- File Certification of Compliance with the Kansas Surface Owner Notification Act (KSONA-1) with Intent to Drill;
- File Drill Pit Application (form CDP-1) with Intent to Drill;
- File Completion Form ACO-1 within 120 days of spud date;
- File acreage attribution plat according to field proration orders;
- Notify appropriate district office 48 hours prior to workover or re-entry;
- Submit plugging report (CP-4) after plugging is completed (within 60 days);
- Obtain written approval before disposing or injecting salt water.
- If well will not be drilled or permit has expired (See: authorized expiration date) please check the box below and return to the address below.

Well will not be drilled or Permit Expired Date: _____

Signature of Operator or Agent: _____

E
 W

For KCC Use ONLY

API # 15 - _____

IN ALL CASES PLOT THE INTENDED WELL ON THE PLAT BELOW

In all cases, please fully complete this side of the form. Include items 1 through 5 at the bottom of this page.

Operator: _____

Lease: _____

Well Number: _____

Field: _____

Number of Acres attributable to well: _____

QTR/QTR/QTR/QTR of acreage: _____ - _____ - _____ - _____

Location of Well: County: _____

_____ feet from N / S Line of Section

_____ feet from E / W Line of Section

Sec. _____ Twp. _____ S. R. _____ E W

Is Section: Regular or Irregular

If Section is Irregular, locate well from nearest corner boundary.

Section corner used: NE NW SE SW

PLAT

Show location of the well. Show footage to the nearest lease or unit boundary line. Show the predicted locations of lease roads, tank batteries, pipelines and electrical lines, as required by the Kansas Surface Owner Notice Act (House Bill 2032). You may attach a separate plat if desired.

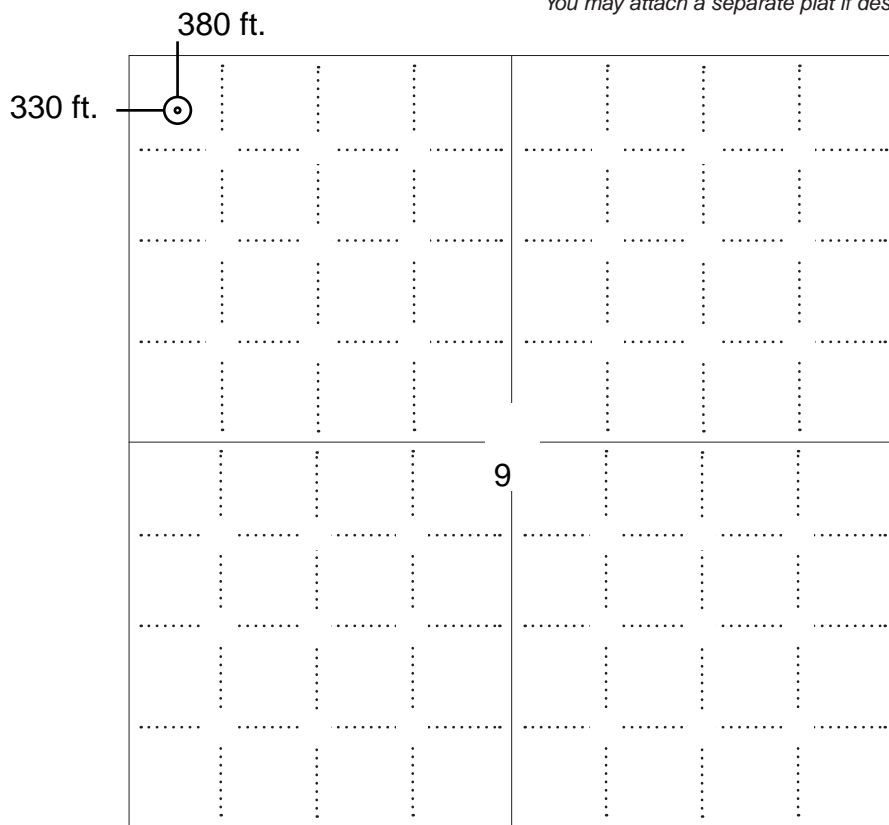

LEGEND

- Well Location
- Tank Battery Location
- Pipeline Location
- Electric Line Location
- Lease Road Location



NOTE: In all cases locate the spot of the proposed drilling locaton.

In plotting the proposed location of the well, you must show:

1. The manner in which you are using the depicted plat by identifying section lines, i.e. 1 section, 1 section with 8 surrounding sections, 4 sections, etc.
2. The distance of the proposed drilling location from the south / north and east / west outside section lines.
3. The distance to the nearest lease or unit boundary line (in footage).
4. If proposed location is located within a prorated or spaced field a certificate of acreage attribution plat must be attached: (C0-7 for oil wells; CG-8 for gas wells).
5. The predicted locations of lease roads, tank batteries, pipelines, and electrical lines.

KANSAS CORPORATION COMMISSION
OIL & GAS CONSERVATION DIVISION

Form CDP-1
May 2010
Form must be Typed

APPLICATION FOR SURFACE PIT

Submit in Duplicate

Operator Name:		License Number:	
Operator Address:			
Contact Person:		Phone Number:	
Lease Name & Well No.:		Pit Location (QQQQ): ____ - ____ - ____ - ____	
Type of Pit: <input type="checkbox"/> Emergency Pit <input type="checkbox"/> Burn Pit <input type="checkbox"/> Settling Pit <input type="checkbox"/> Drilling Pit <input type="checkbox"/> Workover Pit <input type="checkbox"/> Haul-Off Pit <i>(If WP Supply API No. or Year Drilled)</i>		Pit is: <input type="checkbox"/> Proposed <input type="checkbox"/> Existing If Existing, date constructed: _____ Pit capacity: _____ (bbls)	
Is the pit located in a Sensitive Ground Water Area? <input type="checkbox"/> Yes <input type="checkbox"/> No		Chloride concentration: _____ mg/l <i>(For Emergency Pits and Settling Pits only)</i>	
Is the bottom below ground level? <input type="checkbox"/> Yes <input type="checkbox"/> No		Artificial Liner? <input type="checkbox"/> Yes <input type="checkbox"/> No	
How is the pit lined if a plastic liner is not used?			
Pit dimensions (all but working pits): _____ Length (feet) _____ Width (feet) <input type="checkbox"/> N/A: Steel Pits Depth from ground level to deepest point: _____ (feet) <input type="checkbox"/> No Pit			
If the pit is lined give a brief description of the liner material, thickness and installation procedure.		Describe procedures for periodic maintenance and determining liner integrity, including any special monitoring.	
Distance to nearest water well within one-mile of pit: _____ feet Depth of water well _____ feet		Depth to shallowest fresh water _____ feet. Source of information: <input type="checkbox"/> measured <input type="checkbox"/> well owner <input type="checkbox"/> electric log <input type="checkbox"/> KDWR	
Emergency, Settling and Burn Pits ONLY: Producing Formation: _____ Number of producing wells on lease: _____ Barrels of fluid produced daily: _____ Does the slope from the tank battery allow all spilled fluids to flow into the pit? <input type="checkbox"/> Yes <input type="checkbox"/> No		Drilling, Workover and Haul-Off Pits ONLY: Type of material utilized in drilling/workover: _____ Number of working pits to be utilized: _____ Abandonment procedure: _____ _____ Drill pits must be closed within 365 days of spud date.	
Submitted Electronically			

KCC OFFICE USE ONLY			
		<input type="checkbox"/> Liner <input type="checkbox"/> Steel Pit <input type="checkbox"/> RFAC <input type="checkbox"/> RFAS	
Date Received: _____		Permit Number: _____	
Permit Date: _____		Lease Inspection: <input type="checkbox"/> Yes <input type="checkbox"/> No	

KANSAS CORPORATION COMMISSION
OIL & GAS CONSERVATION DIVISION

Form KSONA-1

July 2021

Form Must Be Typed

Form must be Signed

All blanks must be Filled

**CERTIFICATION OF COMPLIANCE WITH THE
KANSAS SURFACE OWNER NOTIFICATION ACT**

This form must be submitted with all Forms C-1 (Notice of Intent to Drill); CB-1 (Cathodic Protection Borehole Intent); T-1 (Request for Change of Operator Transfer of Injection or Surface Pit Permit); and CP-1 (Well Plugging Application). Any such form submitted without an accompanying Form KSONA-1 will be returned.

Select the corresponding form being filed: C-1 (Intent) CB-1 (Cathodic Protection Borehole Intent) T-1 (Transfer) CP-1 (Plugging Application)

OPERATOR: License # _____

Name: _____

Address 1: _____

Address 2: _____

City: _____ State: _____ Zip: _____ + _____

Contact Person: _____

Phone: (_____) _____ Fax: (_____) _____

Email Address: _____

Well Location:

____ - ____ - ____ - ____ Sec. ____ Twp. ____ S. R. ____ East West

County: _____

Lease Name: _____ Well #: _____

If filing a Form T-1 for multiple wells on a lease, enter the legal description of the lease below:

Surface Owner Information:

Name: _____

Address 1: _____

Address 2: _____

City: _____ State: _____ Zip: _____ + _____

When filing a Form T-1 involving multiple surface owners, attach an additional sheet listing all of the information to the left for each surface owner. Surface owner information can be found in the records of the register of deeds for the county, and in the real estate property tax records of the county treasurer.

If this form is being submitted with a Form C-1 (Intent) or CB-1 (Cathodic Protection Borehole Intent), you must supply the surface owners and the KCC with a plat showing the predicted locations of lease roads, tank batteries, pipelines, and electrical lines. The locations shown on the plat are preliminary non-binding estimates. The locations may be entered on the Form C-1 plat, Form CB-1 plat, or a separate plat may be submitted.

Select one of the following:

- I certify that, pursuant to the Kansas Surface Owner Notice Act (see Chapter 55 of the Kansas Statutes Annotated), I have provided the following to the surface owner(s) of the land upon which the subject well is or will be located: 1) a copy of the Form C-1, Form CB-1, Form T-1, or Form CP-1 that I am filing in connection with this form; 2) if the form being filed is a Form C-1 or Form CB-1, the plat(s) required by this form; and 3) my operator name, address, phone number, fax, and email address.
- I have not provided this information to the surface owner(s). I acknowledge that, because I have not provided this information, the KCC will be required to send this information to the surface owner(s). To mitigate the additional cost of the KCC performing this task, I acknowledge that I must provide the name and address of the surface owner by filling out the top section of this form and that I am being charged a \$30.00 handling fee, payable to the KCC, which is enclosed with this form.

If choosing the second option, submit payment of the \$30.00 handling fee with this form. If the fee is not received with this form, the KSONA-1 form and the associated Form C-1, Form CB-1, Form T-1, or Form CP-1 will be returned.

I Submitted Electronically

I

For KCC Use ONLY

API # 15-

IN ALL CASES PLOT THE INTENDED WELL ON THE PLAT BELOW

In all cases, please fully complete this side of the form. Include items 1 through 5 at the bottom of this page.

Operator: JEL Resources, LLC
 Lease: Betty Hullman Estate
 Well Number: 2-9
 Field Beshorn
 Number of Acres attributable to well: 160
 QTR/QTR/QTR/QTR of acreage: _____ - NW - NW - NW

Location of Well: County: Stafford
 _____ feet from N / _____ S Line of Section
 _____ feet from E / W Line of Section
 Sec. 9 Twp. 22 S. R. 13 _____ E W

Is Section: Regular or Irregular

If Section is Irregular, locate well from nearest corner boundary.

Section corner used: NE NW SE SW

PLAT

Show location of the well. Show footage to the nearest lease or unit boundary line. Show the predicted locations of lease roads, tank batteries, pipelines and electrical lines, as required by the Kansas Surface Owner Notice Act (House Bill 2032). You may attach a separate plat if desired.

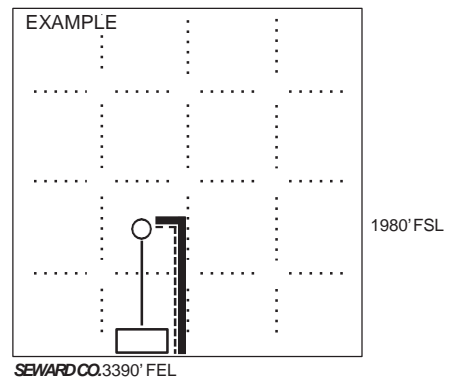
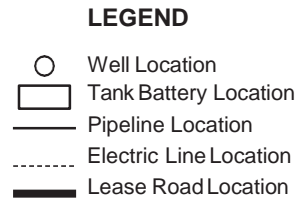
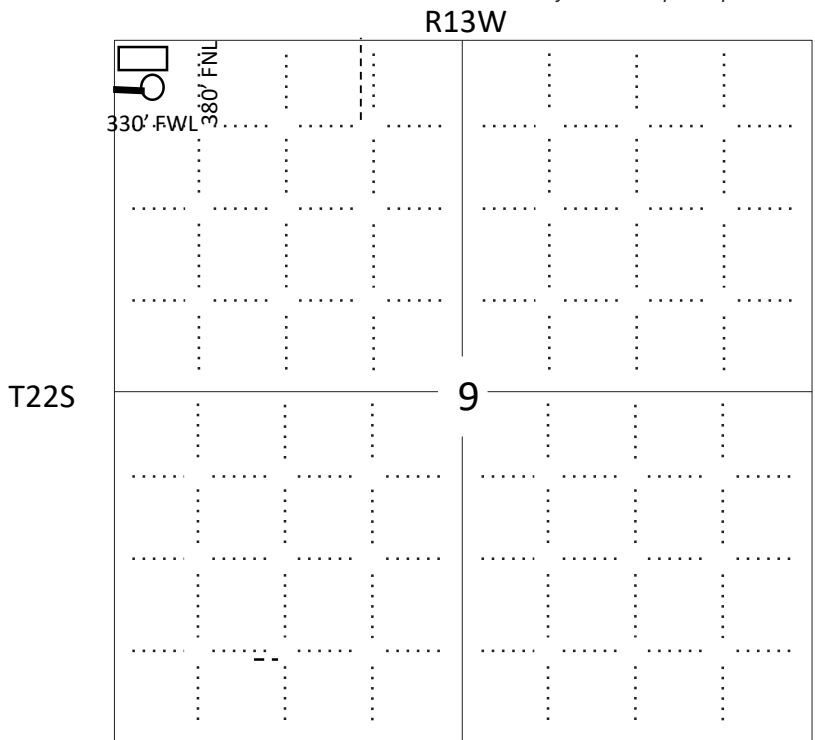

NOTE: In all cases locate the spot of the proposed drilling location.

In plotting the proposed location of the well, you must show:

1. The manner in which you are using the depicted plat by identifying section lines, i.e. 1 section, 1 section with 8 surrounding sections, 4 sections, etc.
2. The distance of the proposed drilling location from the south / north and east / west outside section lines.
3. The distance to the nearest lease or unit boundary line (in footage).
4. If proposed location is located within a prorated or spaced field a certificate of acreage attribution plat must be attached: (C0-7 for oil wells; CG-8 for gas wells).
5. The predicted locations of lease roads, tank batteries, pipelines, and electrical lines.

JEL RESOURCES, LLC
BETTY HULLMAN ESTATE LEASE
NW. 1/4, SECTION 9, T22S, R13W
STAFFORD COUNTY, KANSAS

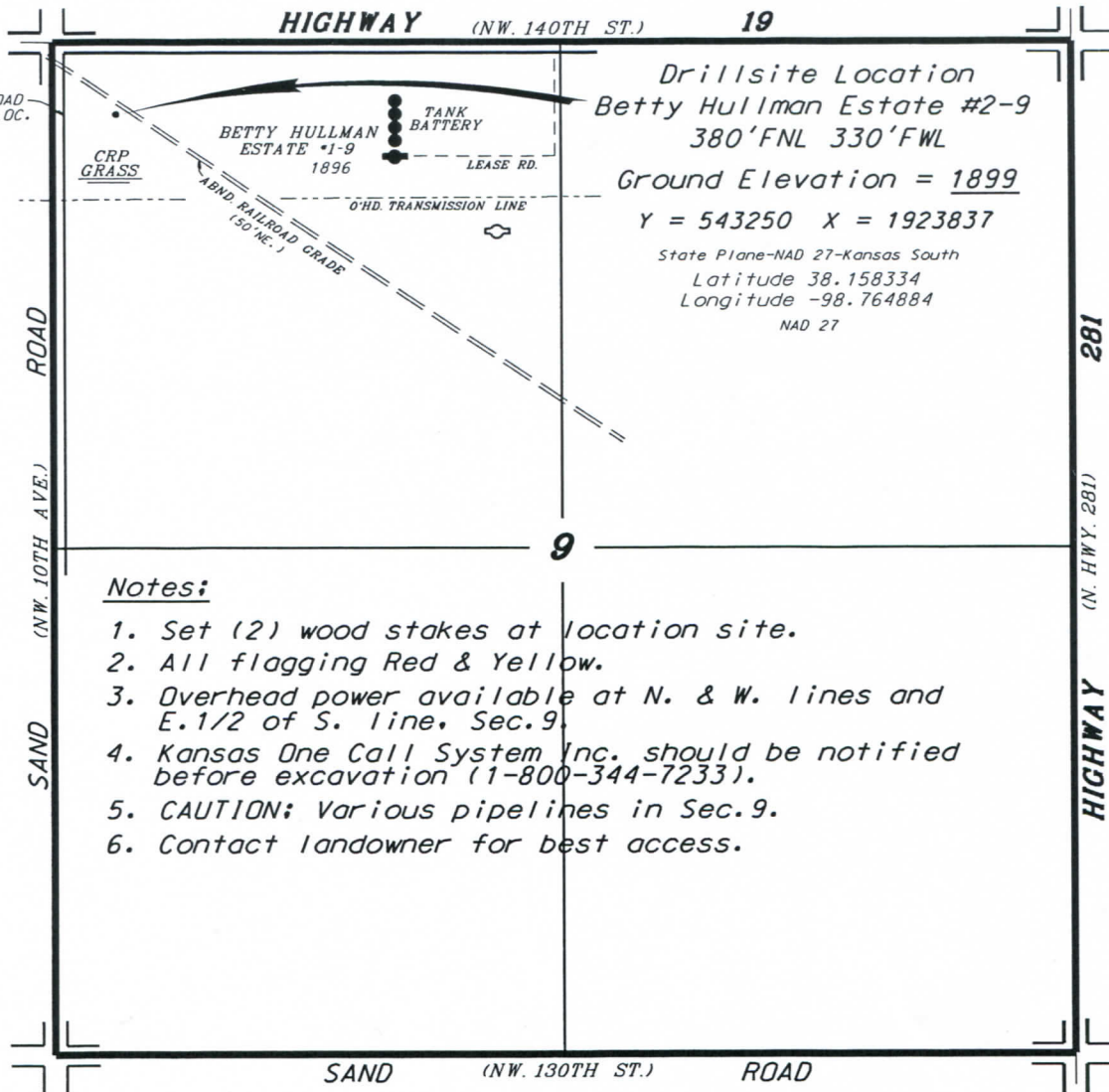

Notes:

1. Set (2) wood stakes at location site.
2. All flagging Red & Yellow.
3. Overhead power available at N. & W. lines and E. 1/2 of S. line, Sec. 9.
4. Kansas One Call System Inc. should be notified before excavation (1-800-344-7233).
5. CAUTION: Various pipelines in Sec. 9.
6. Contact landowner for best access.

*Ingress and egress to location as shown on this plat is per usage only and may not be legally opened for public use. Contact landowner, tenant and county road department for access.

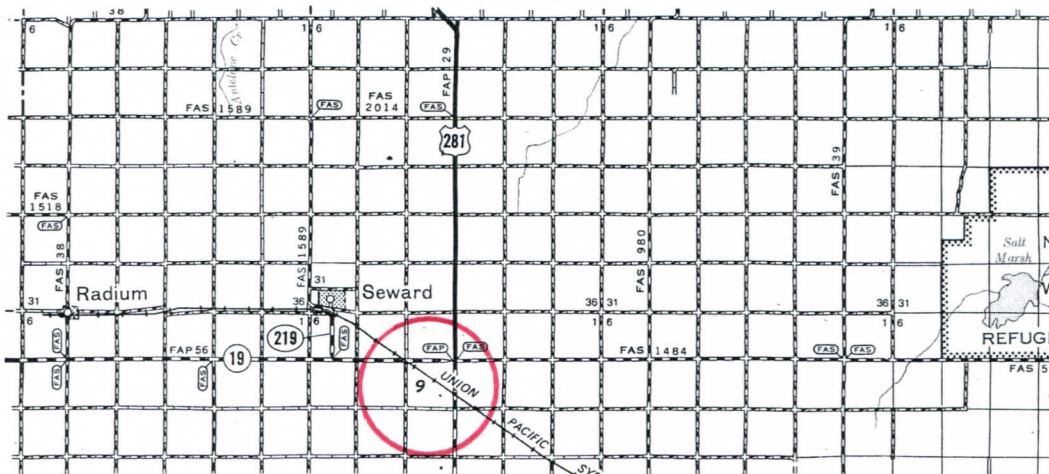

*Controlling data is based upon the best maps and photographs available to us and upon a regular section of land containing 640 acres.

*Approximate section lines were determined using the normal standard of care of oilfield surveyors practicing in the state of Kansas. The section corners, which establish the precise section lines, were not necessarily located, and the exact location of the drillsite location in the section is not guaranteed. Therefore, the operator securing this service and accepting this plat and all other parties relying thereon agree to hold Central Kansas Oilfield Services, Inc., its officers and employees harmless from all losses, costs and expenses and said entities released from any liability from incidental or consequential damages.

*Elevations derived from National Geodetic Vertical Datum.

Date April 20, 2022

CENTRAL KANSAS OILFIELD SERVICES, INC. (620)792-1977

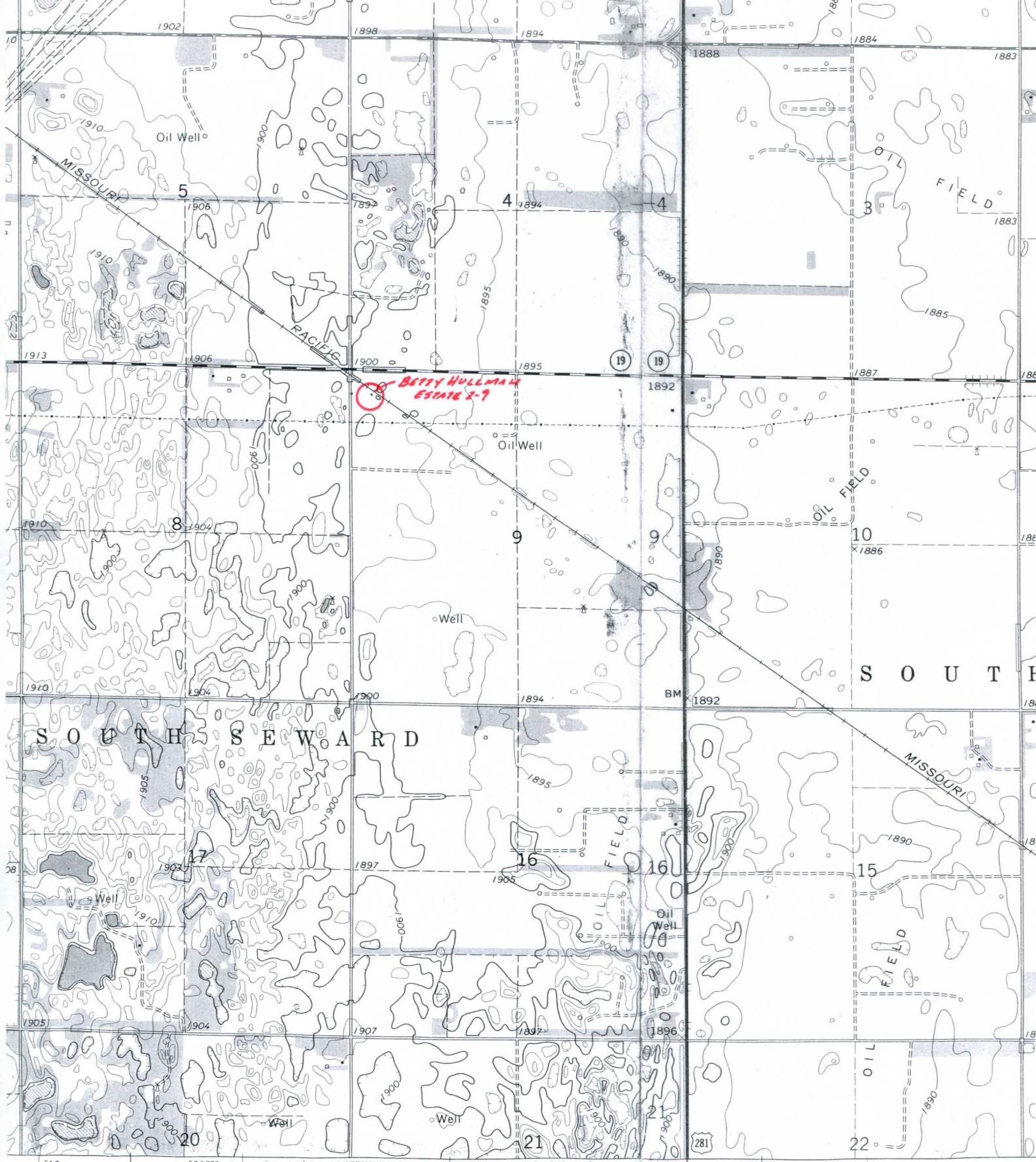

ROAD CLASSIFICATION

Secondary highway, all weather, Light-duty road, all weather, hard surface ——— improved surface
 Unimproved road, fair or dry weather ———
 weather ———

○ State Route

Mapped, edited, and published by the Geological Survey

Control by USGS and USC&GS

Topography by photogrammetric methods from aerial photographs taken 1969. Field checked 1970

Polyconic projection. 1927 North American datum
 10,000-foot grid based on Kansas coordinate system, south of
 1000-meter Universal Transverse Mercator grid ticks,
 zone 14, shown in blue

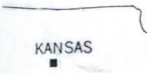

519 520000m E ● ☆U.S. GOVERNMENT PRINTING OFFICE: 1972-460-348/1 98° 45' ST. JOHN 9 MI. PRATT 34 MI. 523

May 02, 2022

Michael S Connelly
JEL Resources, LLC
6545 South Riviera Way, Aurora, CO, USA
Aurora, CO 80016-3830

Re: Drilling Pit Application
Betty Hullman Estate 2-9
NW/4 Sec.09-22S-13W
Stafford County, Kansas

Dear Michael S Connelly:

District staff has inspected the above referenced location and has determined that an unsealed condition will present a pollution threat to water resources.

District staff has recommended that the reserve pit be lined with bentonite or native clay, constructed **without slots**, the bottom shall be flat and reasonably level and the free fluids must be removed. The fluids are to be removed from the reserve pit as soon as the Hutchinson Salt section has been drilled through and displacement of the fluids into the reserve pit has occurred. The fluids should be removed again within 72 hours after drilling operations have ceased.

If production casing is set all completion fluids shall be removed from the working pits daily. NO completion fluids or non-exempt wastes shall be placed in the reserve pit.

The fluids should be taken to an authorized disposal well. Please call the District Office at (620) 682-7933 when the fluids have been removed. Please file form CDP-5 (August 2008), Exploration and Production Waste Transfer, through KOLAR within 30 days of fluid removal.

A copy of this letter should be posted in the doghouse along with the approved Intent to Drill. If you have any questions or concerns please feel free to contact the District Office at (620) 682-7933.